

KGUARD[®]
SECURITY

EN

USER MANUAL

HD Series

HD482 / HD882 / HD1682

Default user name: admin

Default password: 123456

SAFETY INSTRUCTION	1
Chapter 1 Product Overview	1
1.1 Front View & Rear View	1
1.2 Remote Controller (For Reference Only).....	2
Chapter 2 DVR Installation & Connection	3
2.1 HDD Installation.....	3
2.2 Connection Diagram	4
2.3 Power Supply Connection	4
Chapter 3 DVR Common Operations	5
3.1 Using the Supplied Mouse.....	5
3.2 Using the Virtual Keyboard.....	5
3.3 Password.....	6
Chapter 4 DVR Starting up	7
4.1 Start Wizard	7
4.1.1 Start Wizard	7
4.1.2 Network Configuration	7
4.1.3 Date/Time.....	9
4.1.4 IP Camera	10
4.1.5 Disk	12
4.1.6 Resolution	12
4.1.7 Mobile	13
4.1.8 Summary.....	13
4.2 Live View Screen Overview	14
4.2.1 Camera Quick Toolbar	15
4.2.2 Taskbar.....	15
4.2.3 Start Menu	16
4.2.3.1 Unlock and Lock Screen	16
4.2.3.2 Shutdown.....	17
Chapter 5 DVR System Setup	18
5.1 Channel	18
5.1.1 Channel.....	19
5.1.1.1 Analog Channels	19
5.1.1.2 IP Channels.....	19
5.1.1.3 Protocol Manage	21
5.1.2 Live.....	22
5.1.3 Image Control	23
5.1.4 PTZ	24
5.1.4.1 PTZ control	24
5.1.5 Motion	26
5.1.6 Video Cover	28
5.2 Record	28
5.2.1 Encode.....	28

5.2.2 Record	29
5.2.2.1 Record	30
5.2.2.2 Record Schedule.....	30
5.2.3 Capture	31
5.2.3.1 Capture	32
5.2.3.2 Capture Schedule	32
5.3 Alarm.....	33
5.3.1 Motion	33
5.3.2 I/O	33
5.3.3 PTZ Linkage.....	34
5.3.4 Exception	35
5.4 Network.....	36
5.4.1 General	36
5.4.1.1 PPPoE	37
5.4.1.2 3G	38
5.4.1.3 Port Configuration	38
5.4.2 DDNS.....	39
5.4.3 Email	40
5.4.3.1 Email Configuration.....	40
5.4.3.2 Email Schedule	41
5.4.4 FTP	42
5.5 Device.....	43
5.5.1 Disk	43
5.5.1.1 S.M.A.R.T	43
5.5.2 Cloud.....	45
5.6 System.....	46
5.6.1 General	46
5.6.1.1 Date and Time.....	47
5.6.1.2 NTP Settings	48
5.6.1.3 DST Settings	48
5.6.2 Output Configuration.....	49
5.6.2.1 LIVE-OUT	50
5.6.3 Multi-user	51
5.6.3.1 Changing Password.....	51
5.6.3.2 Add New Users	52
5.6.3.3 Setting User Permissions.....	52
5.6.4 Maintenance	54
5.6.4.1 Log.....	54
5.6.4.2 Load Default.....	55
5.6.4.3 Upgrade	56
5.6.4.4 Parameter Management	56
5.6.4.4 Auto Reboot	57
5.6.5 IP Camera Maintain	57
5.6.5.1 Upgrade IP Camera	58
5.6.5.2 Load Default Settings for IP Camera.....	58
5.6.6 System Information	59
5.6.6.1 Information	59

5.6.6.2 Channel Information.....	59
5.6.6.3 Record Information.....	60
5.6.6.4 Network State.....	60
Chapter 6 Search, Playback & Backup.....	61
6.1 Using Search Function	61
6.1.1 Search & Play Video in General	63
6.1.1.1 Video Clip Backup.....	63
6.1.2 Event Search, Playback & Backup	65
6.1.2.1 Event Playback Control.....	66
6.1.3 Sub-periods Playback.....	67
6.1.4 Smart Search & Playback.....	68
6.1.4.1 Smart Search Area.....	69
6.1.5 Picture Search & View	70
6.1.5.1 Picture Preview Control.....	71
Chapter 7 Remote Access via Web Client.....	72
7.1 Basic System Environment Requirements	72
7.2 Web Plugin Download and Installation	72
7.3 Web Client Manager	75
7.3.1 Live Interface	75
7.3.2 Playback	77
7.3.2.1 Playback Control Buttons.....	78
7.3.3 Remote Setting	80
7.3.4 Local Setting	80
Chapter 8 Viewing Backed Up Video on PC/Mac	81
Chapter 9 Remote Access via Mobile Devices	84
Chapter 10 Appendix.....	86
10.1 Troubleshooting	86
10.2 Usage Maintenance.....	87

SAFETY INSTRUCTION

Please carefully read the following safety instruction so as to avoid personal injuries and prevent the equipment and other connection devices from being damaged.

1. Power sources (note: please use the power supply attached or specified by the manufacturer)

Never operate the equipment by using unspecified power supply.

2. Never push objects of any kind through openings of DVR

Never push objects of any kind through openings of DVR so as to avoid electric shock or other accidents.

3. Do not put the equipment in the dusty field

Do not put the equipment in the dusty field.

4. Do not place the equipment under rain or humid environment

Do not place the equipment under humid environment like basement. If the equipment is accidentally in contact with water, please unplug the power cable and immediately contact your local dealer.

5. Keep the surface of the equipment clean and dry

Use soft damp cloth to clean the outer case of DVR (do not use liquid aerosol cleaners)

6. Do not operate if any problems are found

If there are any strange smell or sound from DVR, unplug the power cable and contact the authorized dealer or service center.

7. Do not try to remove the upper cover

Warning: Do not remove the cap of DVR so as to avoid electric shock.

8. Handle with care

If DVR does not work normally because of hitting on the hard object, please contact the authorized dealer for repair or replacement.

9. Use standard lithium battery (Note: Use the batteries attached or specified by the manufacturer)

After cutting off the power supply, if the system clock cannot continue to work, please replace the standard 3V lithium battery on the main board.

Warning: Turn off DVR before replacing the batteries, or you may be suffered from serious electric shock. Please properly dispose of the used batteries.

10. Put the equipment in a place with good ventilation

The DVR system includes HDD, which produces large amount of heat during operation. As a result, do not block the ventilation openings (on the top, bottom, both sides and the reverse side) for cooling the system during operation. Install or put the equipment in the place with good ventilation.

11. The attached power adapter can only be used for 1 set of DVR. Do not connect more equipment, or DVR may be restarted repeatedly because of insufficient power.

12. Prevent the equipment from water dropping or splashing. Do not place objects containing water, such as flower vase, on the equipment.

Chapter 1 Product Overview

1.1 Front View & Rear

NOTE: The front view of the product is similar for 4-channel, 8-channel, and 16-channel DVR.

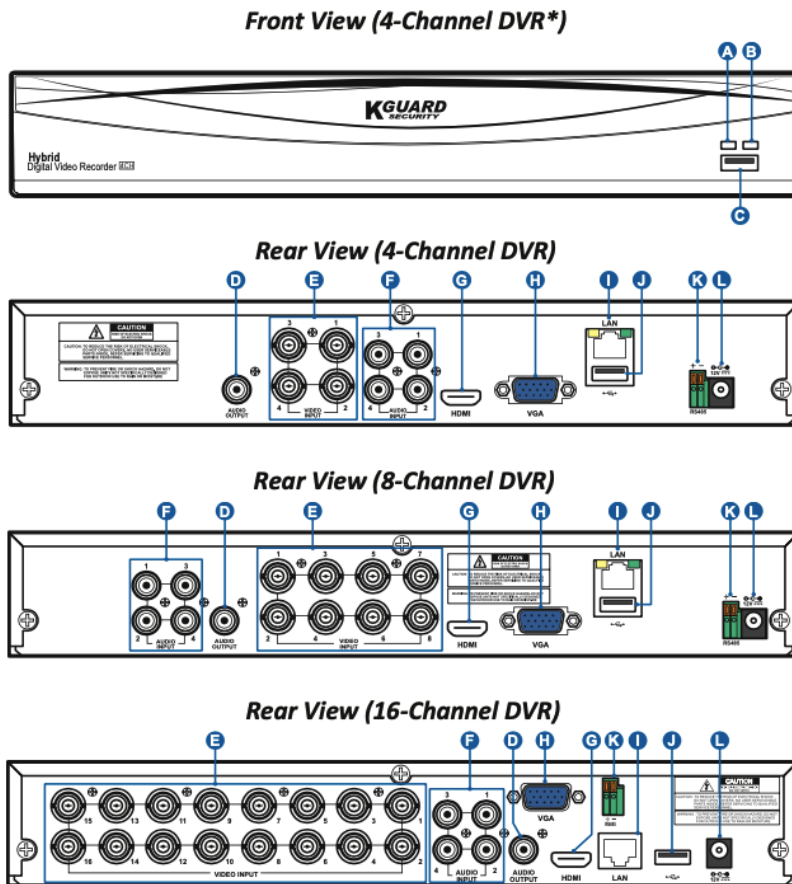

A) HDD LED - This will flash when the hard drive is working.

B) Power LED - This light will turn on when the DVR has power. **C) USB** - Connect the supplied mouse here.

D) Audio Out - For connecting speakers.

E) Video In - This is where you connect the cameras.

NOTE: To ensure the image quality, we recommend you to use the supplied KGUARD cameras, or purchase separately KGUARD Megapixel CCTV Cameras.

F) Audio In - For connecting microphones.

G) HDMI - Connect this to your digital TV or monitor with HDMI input. **H) VGA** - Connect this to your TV or a monitor with VGA input.

I) LAN - Connect this to your home network, so that your DVR can be accessed through Internet. In addition to connecting to a network, you can also access the local or remote ONVIF IP cameras.

J) USB - Connect the USB flash drive to backup recorded events. **K) RS485** - Connects to a Speed dome camera via RS485.

L) Power - This is where you connect the power adapter.

1.2 Remote Controller (For Reference Only)

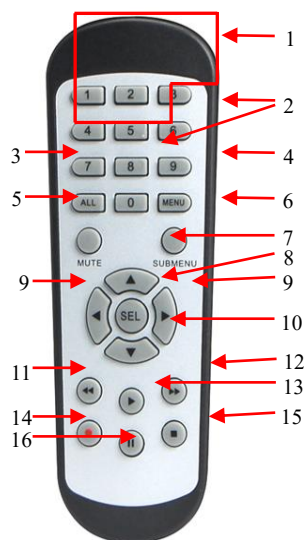

Table 2-1

No.	Icon	Description
1	1-8	Numeric keys Press to display channel 1~8
2	9、0	Numeric keys
3	ALL	Press to display all channels Multiple display mode
4	Menu	Press to enter or exit the Main Menu
5	Mute	Mute On/off
6	Submenu	Go to submenu
7	▲	Up arrow key; Volume increase
8	SEL	Press to enter the selected menu item and edit the setting
9	◀▶	Left/Right key; Decrease/increase parameter value of control bar.
10	▼	Down arrow key; Volume decrease
11	◀◀	Press to rewind during video playback
12	▶▶	Press to fast forward during video playback
13	▶	Press to play recorded video or enter the recording search menu
14	●	Press to start manual recording
15	■	Press to stop manual recording or stop the video playback
16		Press to pause the video playback or enter frame-playback mode

Chapter 2 DVR Installation & Connection

2.1 HDD Installation

Depending on the package you have purchased, the hard disk drive may be included in the full package. If it is not pre-installed, follow the installation instructions on this user manual.

Caution: DO NOT install or remove the hard disk drive while the device power is turned ON.

HDD Installation:

- (1) Cut power firstly, and then remove screws on both sides & rear panel, and open DVR upper cover.

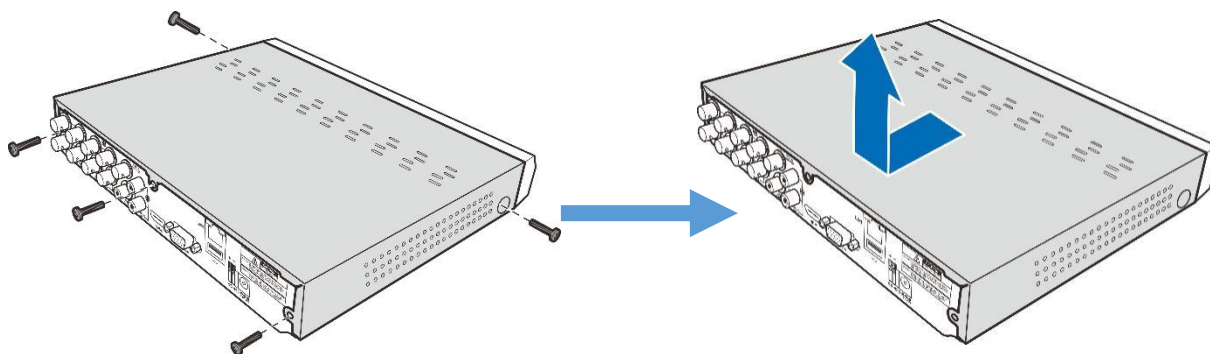

- (2) Connect the data and power cables to the HDD and place the HDD on the DVR case. Carefully flip the DVR case and secure the HDD to the DVR with the screws.

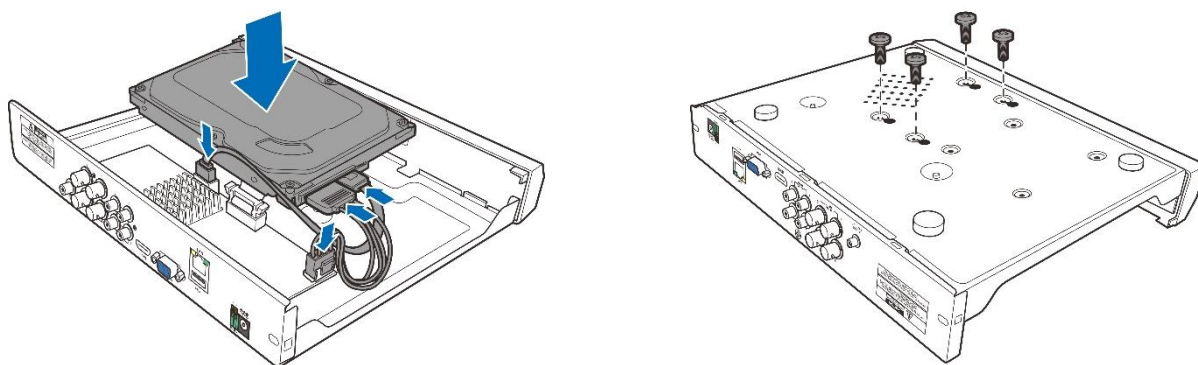

- (3) Put the upper cover back carefully, and fix the cover with screws.

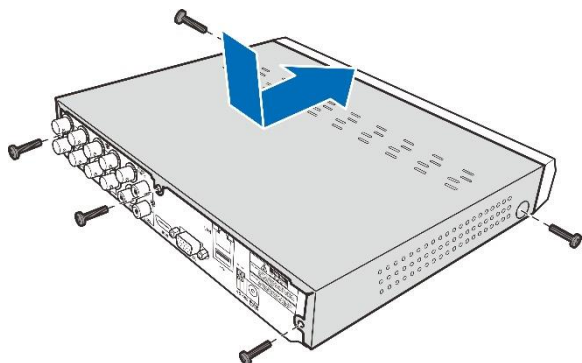

Note: Above procedures are for reference only. The practical operation may be different depending on the DVR you purchased.

2.2 Connection Diagram

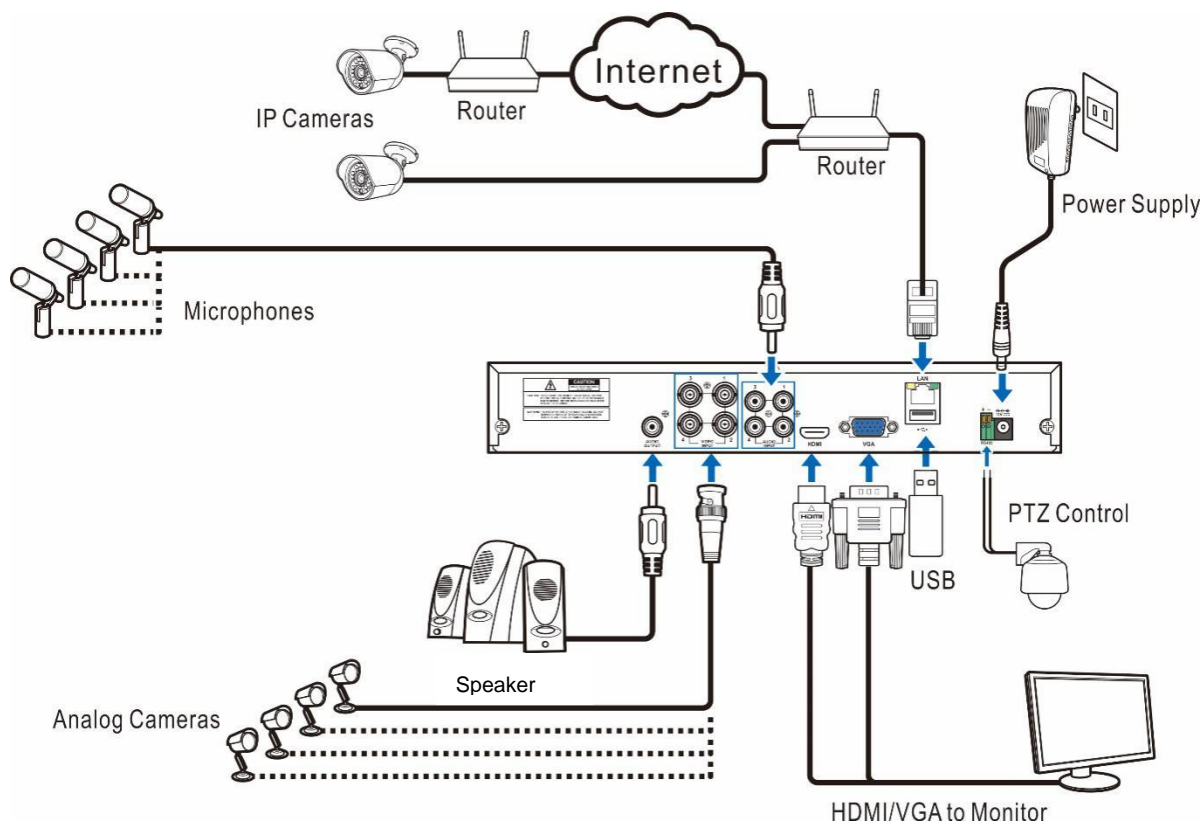

Note: Above diagram is for reference only. The practical connection may be different depending on the DVR you purchased.

2.3 Power Supply Connection

Caution: Use only the supplied power adapter that came with the DVR

Connect one end of the power adapter to the power connector on the back of the DVR. Plug the other end of the power adapter (12V2A) into the wall outlet.

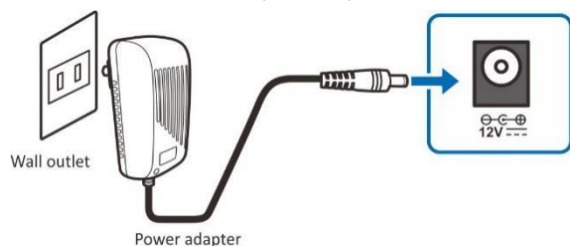

Chapter 3 DVR Common Operations

3.1 Using the Supplied Mouse

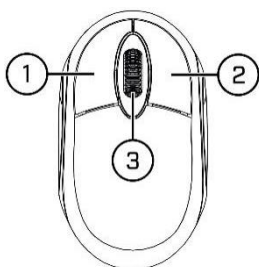

1. Left Button:

- Click to select menu options.
- During live viewing in split-screen view, double-click on a channel to view it in full-screen. Double-click the channel again to return to split-screen viewing.
- Click upon a channel on Live Viewing screen to open Camera Quick Toolbar.
- Click and hold to drag sliders and scales on menu mode

2. Right Button:

- Click once to open the Taskbar on the Live Viewing screen. View Taskbar on [4.2.2 Taskbar](#)
- In menus, click to go back / close menus.

3. Scroll Wheel:

- In menus, scroll to move up / down through the menu content.
- While hovering over the volume control wheel, scroll to turn system volume up / down.

3.2 Using the Virtual Keyboard

You will see the virtual keyboard automatically on the screen when you need to enter data

Click to toggle the keyboard to upper case and more punctuation

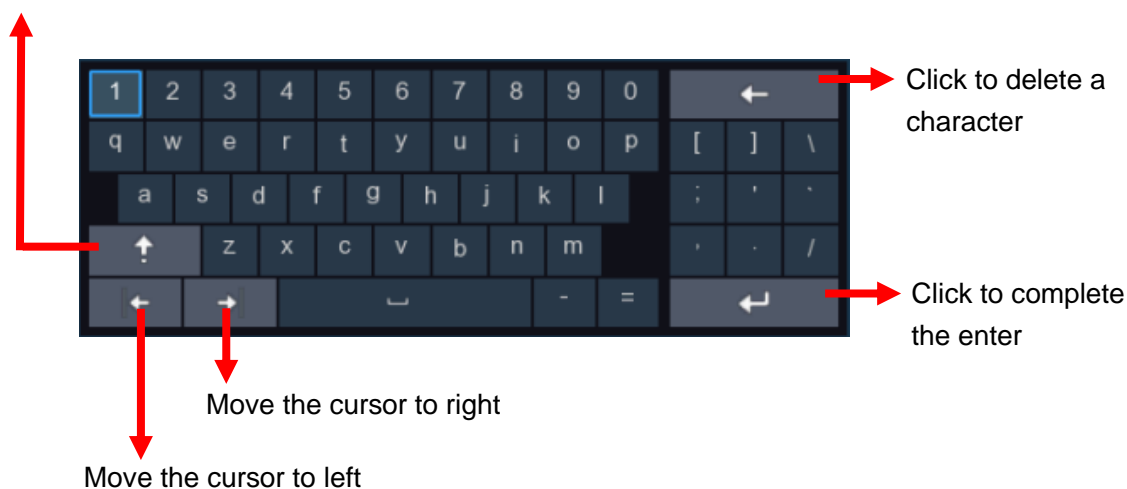

3.3 Password

For the first time when you run the DVR, you must be required to set your own password immediately in order to protect your privacy. Please be sure to record your username and password and save them in a secure place. **(Default Factory Account/Password: admin/123456)**

The screenshot shows a configuration screen with the following elements:

- Language:** A dropdown menu set to "ENGLISH".
- Device ID:** A text input field containing "000000" with "(000000)" in parentheses to its right.
- New Admin Name:** A text input field containing "admin".
- New Admin Password:** A password input field with a "Show Password" checkbox to its right.
- Confirm Password:** A password input field with a "Show Password" checkbox to its right.
- Apply:** A button at the bottom center of the form.

Language: Choose an OSD language

Device ID: Input the device ID in the parentheses. Default ID is 000000. View more about Device ID on [5.6.1 General](#).

New Admin name: To set your own administrator name.

New Admin Password: To set your own password. The password must be a combination of 6 characters.

Confirm Password: Enter your own password again.

Click **Apply** to confirm your settings and goes to the login interface. Enter your user name & password to **Login** the DVR system.

The screenshot shows a login screen with the following elements:

- Language:** A dropdown menu set to "ENGLISH".
- Device ID:** A text input field containing "000000" with "(000000)" in parentheses to its right.
- User:** A dropdown menu set to "admin".
- Password:** A password input field with masked characters (dots) and a "Show Password" checkbox to its right.
- Login:** A button at the bottom center of the form.

NOTE: If you forget your password, you will be unable to login the system, please contact your reseller to reset the password.

Chapter 4 DVR Starting up

4.1 Start Wizard

Startup Wizard will help to configure the system and get the DVR works quickly.

4.1.1 Start Wizard

Click the **Start Wizard** to proceed to the next step

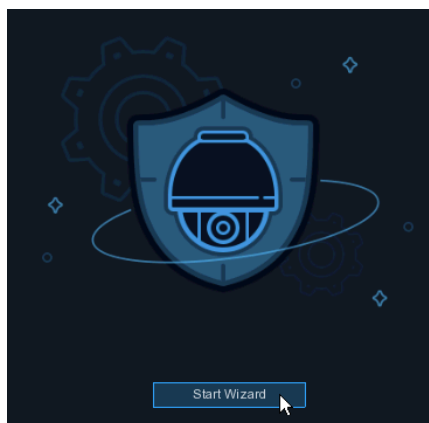

4.1.2 Network Configuration

Local Connection	
DHCP	<input checked="" type="checkbox"/>
IP Address	192.168.006.028
Subnet Mask	255.255.255.000
Gateway	192.168.006.001
DNS	
DNS1	192.168.001.001
DNS2	008.008.008.008
Port	
Web Port	00080
Client Port	09000
RTSP Port	00554
UPNP	<input checked="" type="checkbox"/>

Next Cancel

If you connect to a router allows to use DHCP, please check the **DHCP** box. The router will assign automatically all the network parameters for your DVR. Unless the network is manually addressed below parameters:

IP Address: The IP address identifies the DVR in the network. It consists of four groups of numbers between 0 to 255, separated by periods. For example, "192.168.001.100".

Subnet Mask: Subnet mask is a network parameter which defines a range of IP addresses that can be used in a network. If IP address is like a street where you live then subnet mask is like a neighborhood. The subnet address also consists of four groups of numbers, separated by periods. For example, “255.255.255.000”.

Gateway: This address allows the DVR to access the Internet. The format of the **Gateway** address is the same as the **IP Address**. For example, “192.168.001.001”.

DNS1/DNS2: DNS1 is the primary DNS server and DNS2 is a backup DNS server. Usually should be enough just to enter the DNS1 server address.

Port

Web Port: This is the port that you will use to log in remotely to the DVR (e.g. using the Web Client). If the default port 80 is already taken by other applications, please change it.

Client Port: This is the port that the DVR will use to send information through (e.g. using the mobile app). If the default port 9000 is already taken by other applications, please change it.

RTSP Port: This is the port that the DVR will be allowed to transmit real-time streaming to other device (e.g. using a streaming Media player.).

UPnP: If you want to log in remotely to the DVR using Web Client, you need to complete the port forwarding in your router. Enable this option if your router supports the UPnP. In this case, you do not need to configure manually port forwarding on your router. If your router does not support UPnP, make sure the port forwarding is completed manually in your router.

PPPoE

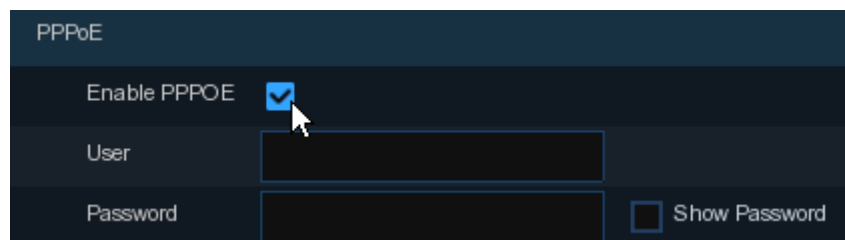

PPPoE

Enable PPPOE

User

Password Show Password

This is an advanced protocol that allows the DVR to connect to the network more directly via DSL modem.

Check the “Enable PPPOE” box, and then enter the User name & Password of the PPPoE.

3G

This is a prior using the mobile network, you need to connect a 3G dongle to the DVR.

Enable the 3G option, enter the APN, Dial Code, User name & password according to the instruction of your 3G dongle device.

4.1.3 Date/Time

This menu allows you to configure the Date, Time, Date Format, Time Format, Time Zone, NTP and DST.

Date and Time

Click on the calendar icon to set the current system date.



Date: Click on the calendar icon to set the system date.

Time: Click to set the system time.

Date Format: Choose from the dropdown menu to set preferred date format.

Time Format: Choose time format between 24Hour and 12Hour.

Time Zone: Set the correct time zone.

NTP

NTP stands for Network Time Protocol. This feature allows you to synchronize the date and time automatically on the DVR over Internet. Therefore, the DVR needs to be connected to the Internet.

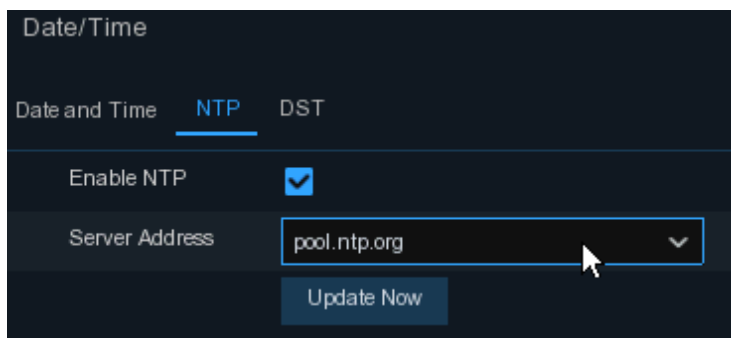

Check the “NTP” box, and select the NTP server.

DST

DST stands for Daylight Savings Time.

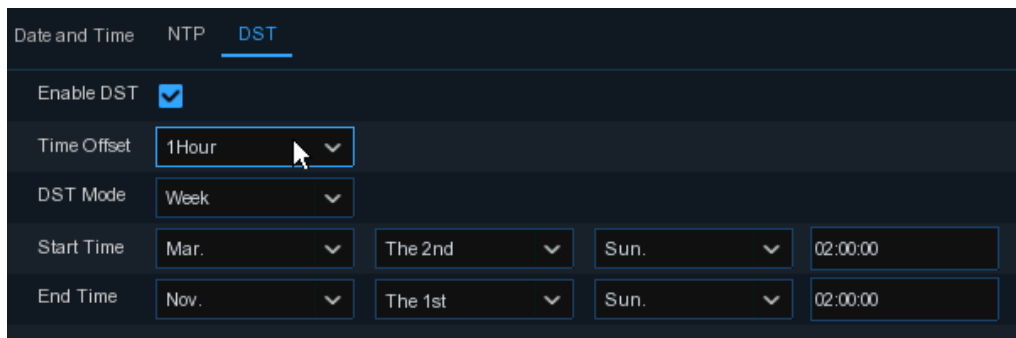

DST: Enable if Daylight Saving Time (DST) is observed in your region

Time Offset: Select the amount of time to offset for DST

Time Mode: Choose to set the daylight saving time in weeks or in days

Start Time/End Time: Set the start time and end time for daylight saving

4.1.4 IP Camera

This menu allows you to add IP cameras to the DVR.

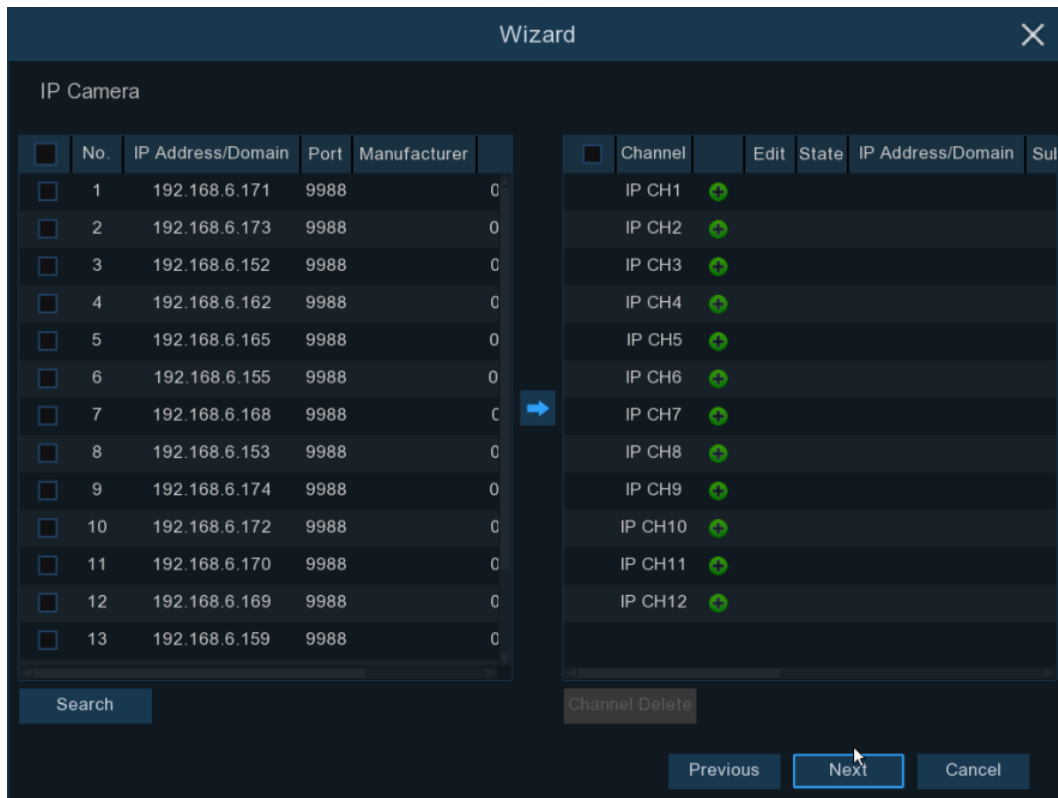

No.	IP Address/Domain	Port	Manufacturer
1	192.168.6.171	9988	
2	192.168.6.173	9988	
3	192.168.6.152	9988	
4	192.168.6.162	9988	
5	192.168.6.165	9988	
6	192.168.6.155	9988	
7	192.168.6.168	9988	
8	192.168.6.153	9988	
9	192.168.6.174	9988	
10	192.168.6.172	9988	
11	192.168.6.170	9988	
12	192.168.6.169	9988	
13	192.168.6.159	9988	

Channel	Edit	State	IP Address/Domain	Sul
IP CH1		+		
IP CH2		+		
IP CH3		+		
IP CH4		+		
IP CH5		+		
IP CH6		+		
IP CH7		+		
IP CH8		+		
IP CH9		+		
IP CH10		+		
IP CH11		+		
IP CH12		+		

Click **Search** to search IP cameras in the same network. Choose the IP camera(s) you want to add, and then click  icon to add to the DVR.

Position: Left-Top

Port: 9988 Auto

Protocol: Private Auto

User Name: admin

Password: Show Password

Add Cancel

Enter the camera’s user name & password to add the camera(s).

You can also click **+** button to add individual IP camera to a single channel.

Add IP Camera

No	IP Address/Domain	Port	Manufacturer	Device Type	MAC Address	Software Version
1	192.168.1.151	9988		IP Camera	B7-91-06-21-D9-1F	
2	192.168.1.152	9988		IP Camera	02-18-09-3B-A7-BB	
3	192.168.1.153	9988		IP Camera	E1-A1-66-94-46-B9	
4	192.168.1.154	9988		IP Camera	CF-C1-11-5A-CA-7A	
5	192.168.1.155	9988		IP Camera	B3-5B-52-54-0B-1D	
6	192.168.1.156	9988		IP Camera	6B-EC-57-ED-06-19	
7	192.168.1.157	9988		IP Camera	74-E4-95-CE-40-D3	
8	192.168.1.158	9988		IP Camera	E0-56-51-B3-8E-58	
9	192.168.1.159	9988		IP Camera	63-7A-76-1A-58-95	
10	192.168.1.160	9988		IP Camera	05-DA-0A-16-EA-CA	

IP Address/Domain: 192.168.1.151

Alias: CH17

Position: Left-Top

Port: 9988

Protocol: Private

User Name: admin

Password: Show Password

Bind channel: CH17

Search Add Cancel

Click **Search** button to search IP cameras, and then click one of the IP camera in the device list.

IP Address/Domain: IP address or domain name of the IP camera

Alias: Name of the IP camera

Position: Position to display the camera name on the screen.

Port: Port of the IP camera

Protocol: Choose the protocol of the IP camera from the dropdown menu

User Name: User Name of the IP camera

Password: Password of the IP camera

Bind channel: Choose a channel of the DVR you want to attach to

4.1.5 Disk

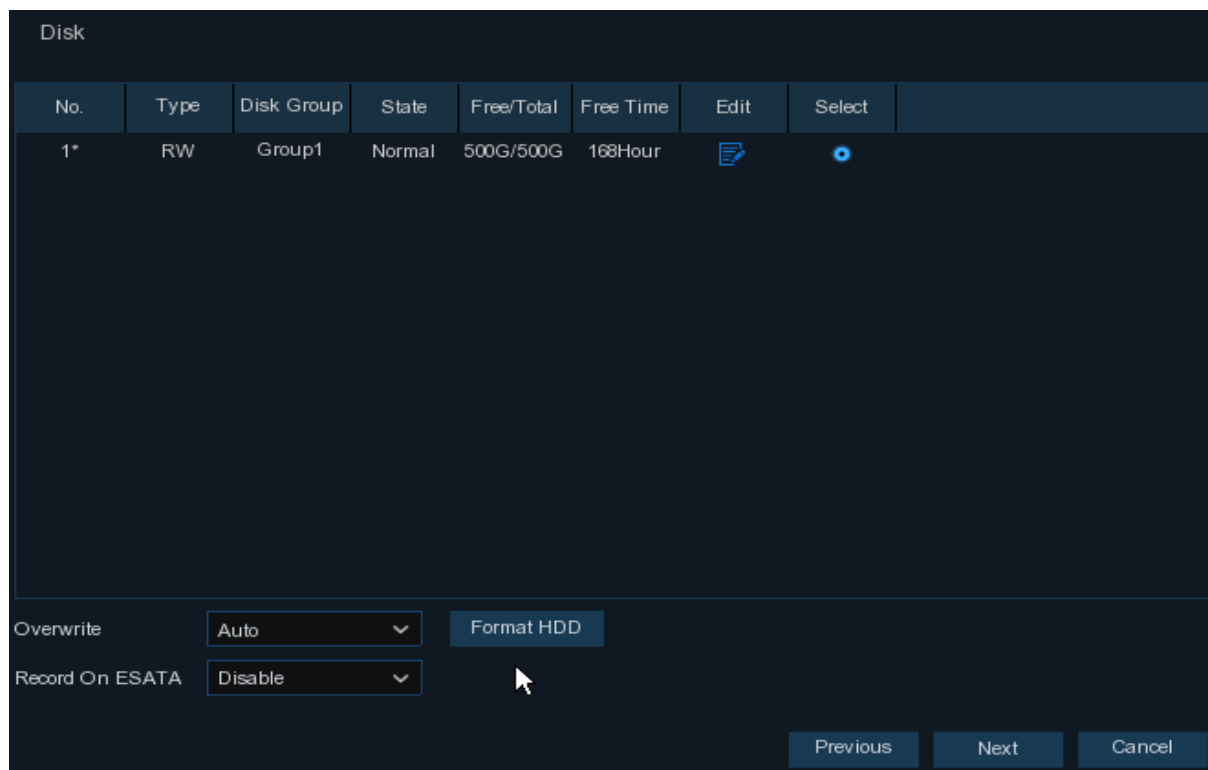

If the HDD is installed in the DVR for the first time, it must be formatted. Select the HDD and then click **Format HDD** button to format the HDD.

Overwrite: Use this option to overwrite the old recordings on the HDD when the HDD is full. For example, if you choose the option 7 days then only the last 7 days recordings are kept on the HDD. To prevent overwriting any old recordings, select Disable. If you have disabled this function, please check the HDD status regularly, to make sure the HDD is not full.

Record On ESATA: If your DVR comes with an e-SATA port on the rear panel, you can enable to record the video to e-SATA HDD.

4.1.6 Resolution

Choose an output resolution matches to your monitor. The DVR supports to adjust the output resolution automatically to match the best resolution of your monitor when the system is starting up.

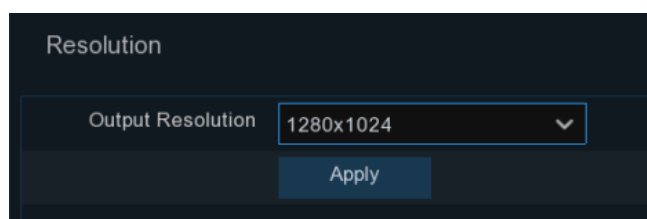

4.1.7 Mobile

If your DVR come with a P2P ID, you can scan the QR code with your mobile app to view the DVR remotely.



4.1.8 Summary

You can check the system summary information you had set in the start wizard and finish the wizard.

Tick **“Don't show this window next time”** if you don't want to display Start Wizard when system reboot next time. Click **Finish** button to save & exit.

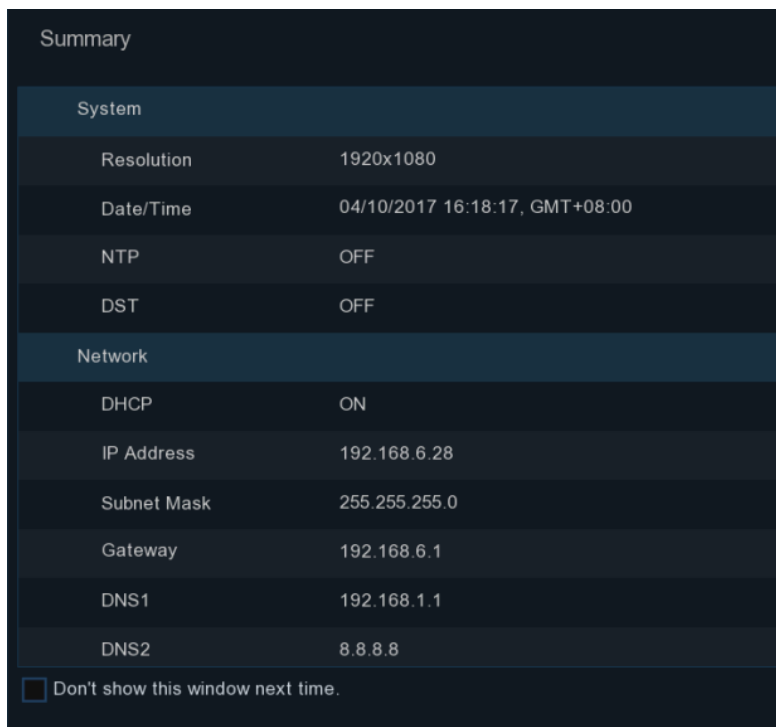

4.2 Live View Screen Overview

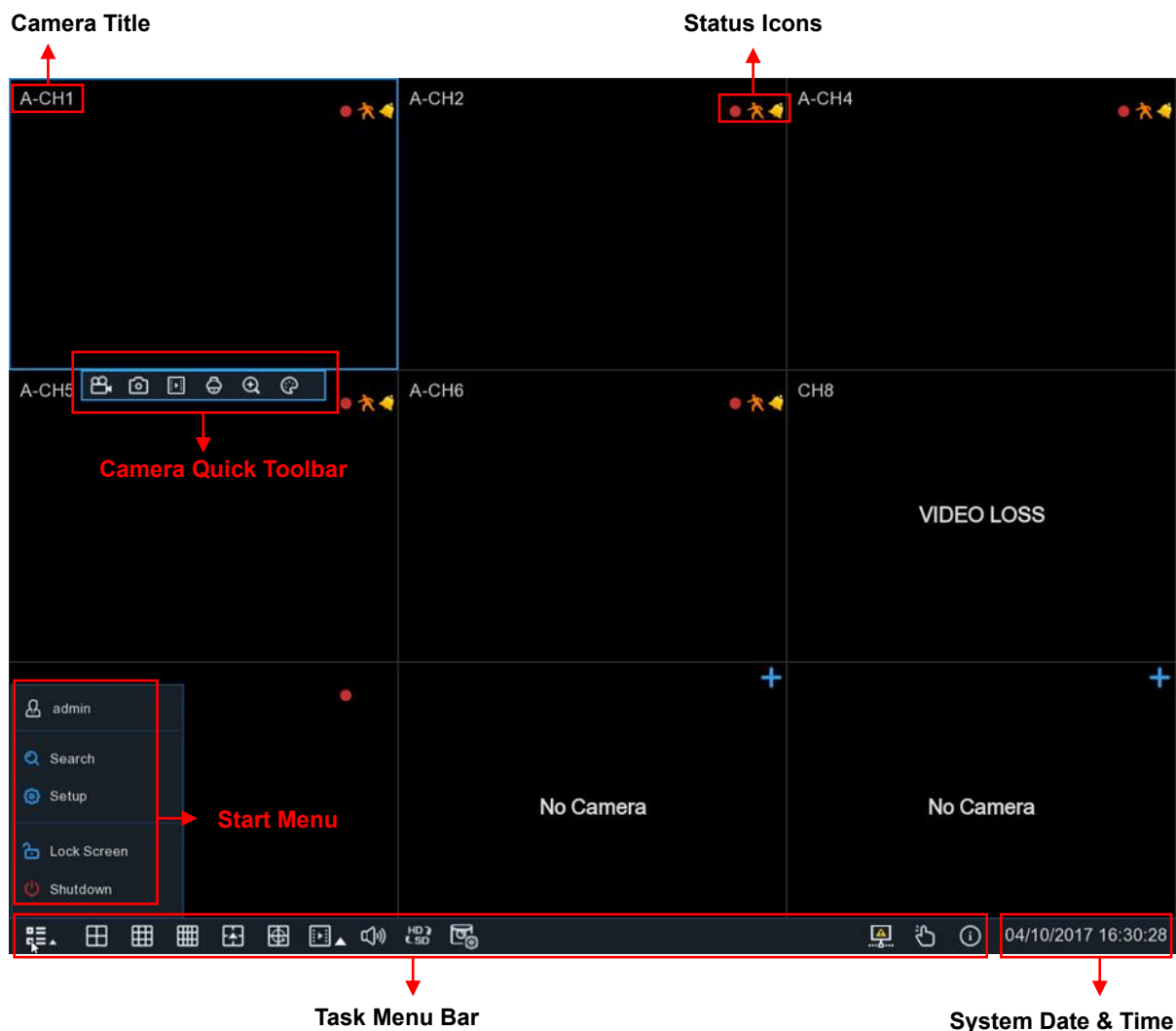

Camera Title

To display the camera title







A-: This indicates that the camera connected is an AHD camera

T-: This indicates that the camera connected is a TVI camera

C-: This indicates that the camera connected is a CVI camera

IP: This indicates that the camera connected is an IP camera

Status Icons

-  This indicates that the DVR is currently recording.
-  This icon appears when the camera has detected motion.
-  The icon indicates that the external I/O alarm device is triggered
-  This icon indicates that the HDD is in error to work
-  This icon indicates the HDD is unformatted
-  This icon indicates the HDD is full.

 This icon indicates the HDD is read-only.

VIDEO LOSS: The analog camera is disconnected.

No Camera: IP camera is disconnected.

Decoding Failed: The DVR doesn't support this kind of IP camera compression standard, please change to H.264 compression standard.

 Click to open **Quick Add** menu to add IP camera

 Click to edit current IP camera

4.2.1 Camera Quick Toolbar

In live viewing, click the left button of your mouse on a connected camera to display the Camera Quick Toolbar.





 Click to manually record the channel immediately. If the manually recording is in process, the icon will be in red color. Click one more time to stop manual record.

 Click to save a snapshot of the current camera image. Manual Capture must be enabled to use this feature. For details on enabling Manual Capture, see [5.2.3.1 Capture](#).

 Click to play the latest 5 minutes recording of this channel

 Click to enter PTZ control panel

 Click to zoom-in the channel. When the  icon appears, press and hold the left button of your mouse to drag the area you want to zoom in.

 Click to adjust the image color of the channel. You can adjust the HUE, BRIGHT, CONTRAST & SATURATION of the image.

4.2.2 Taskbar



 Click to open the Start Menu

 Click to choose different layout for live view

 Click to choose more layouts for live view

 Click to start viewing channels in a sequence

 Quick playback. You can choose to play the latest recording for all channels from the beginning of the day, or you can choose the playback from the latest 5s, 10s, 30s, 1Min, 5Min.

 Click to adjust audio volume

 Click to switch all IP channels between mainstream and substream (for live view resolution)

 Click to switch among real-time, balanced, or smooth view. The view effect modes affect only the live view video quality by bitrate and frame rate but do not affect the recording quality.









 To start or stop Manual Record and Manual Alarm.

 To view system information, channel information, record info and network state.

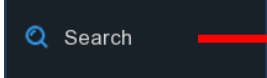

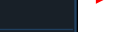
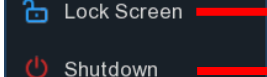

 This icon will appear if the network is disconnected.

4.2.3 Start Menu

With the start menu, you can switch user, search & playback, enter system setup menu, lock & unlock the screen, shut down, reboot & logout the system.

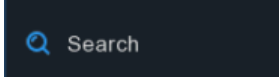
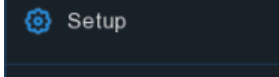
	 To switch user. To enable multi-user, please view on 5.6.3 Multi-user .
	 Search & Playback. View more on Chapter 6 Search, Playback & Backup
	 DVR System Setup. View on Chapter 5 DVR System
	 Lock & unlock screen. View on 4.2.3.1 Unlock and Lock Screen .
	 Shutdown, reboot & logout the system. View on 4.2.3.2 Shutdown .

4.2.3.1 Unlock and Lock Screen

	The screen will be locked to protect unauthorized OSD operation while the DVR is not in menu operation 1 minute.
	
	
	If necessary, you can also lock the screen operation manually. To do so, go to Star Menu, and then click the Lock Screen icon  to lock the system immediately.
	If the system is locked, you can click the Unlock icon  to unlock the system for further operation.

4.2.3.2 Shutdown

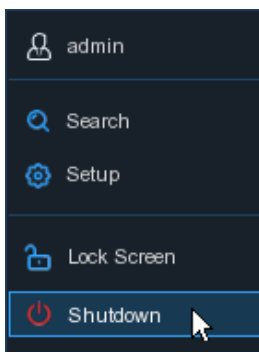

Click the **Shutdown** button from Star Menu, and then check the further action you want to move. Click **OK** button, system will require to input the Admin password to authenticate.

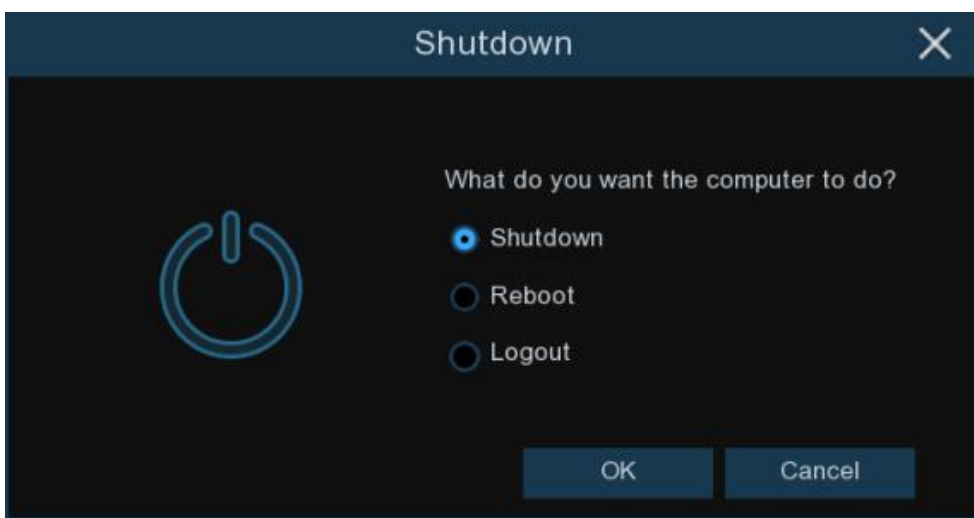

If you choose **Logout** the system, the live viewing screen will be disappeared. You will need to login the system for further operations.

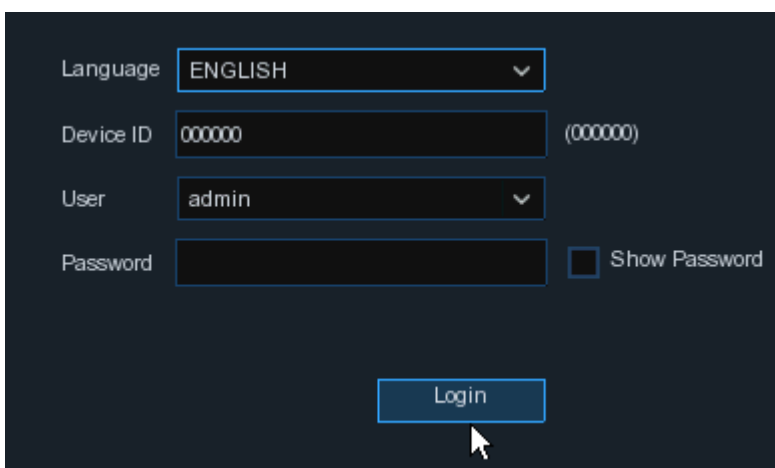

Chapter 5 DVR System Setup

You are able to configure the DVR for Channel, Record, Alarm, Network, Device & System from **Start Menu** → **Setup**.

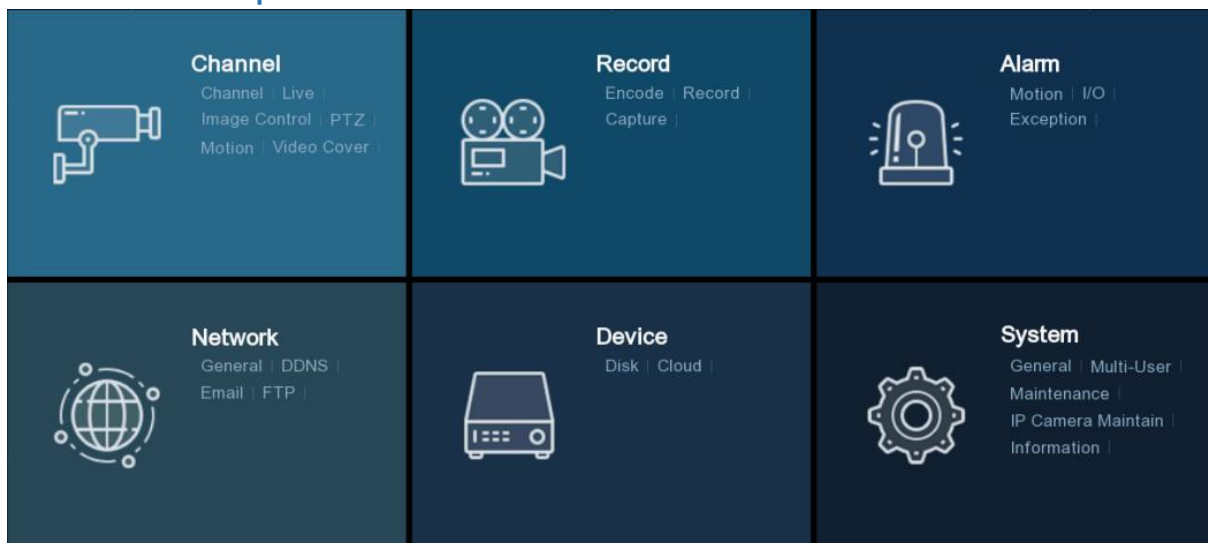

5.1 Channel

In this section, you are allowed to configure the camera, live view display, manage IP cameras, adjust IP camera’s image, PTZ setup, and motion setup, convert mode, and more.

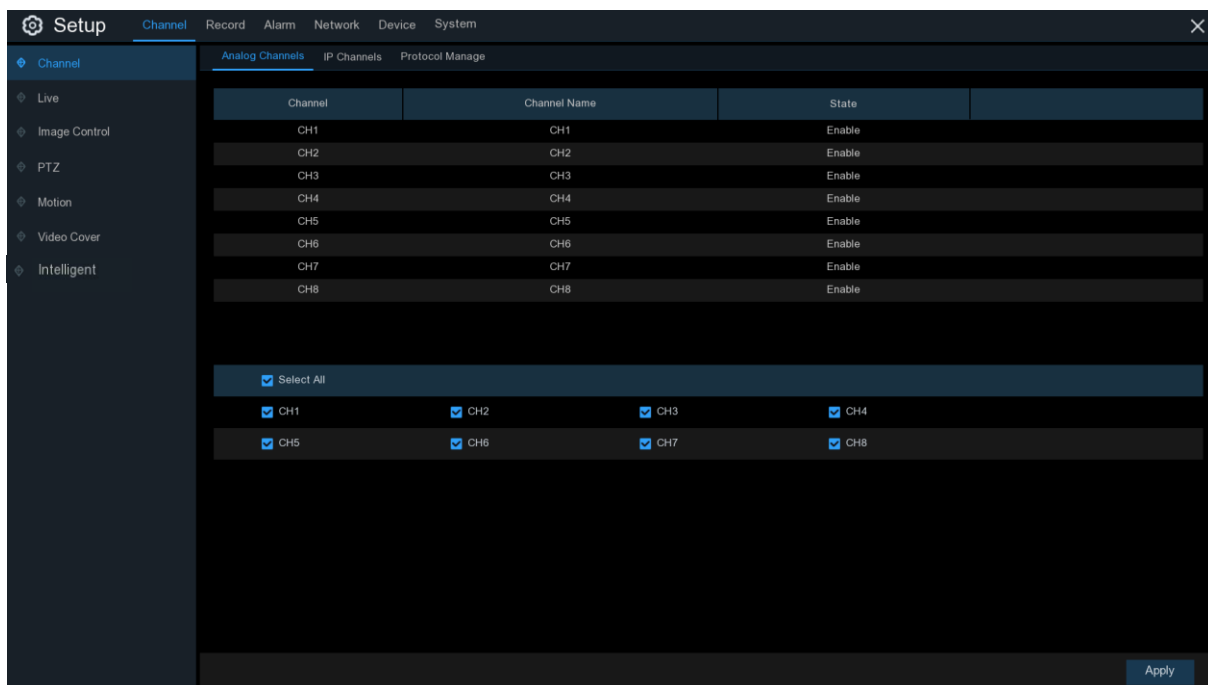

5.1.1 Channel

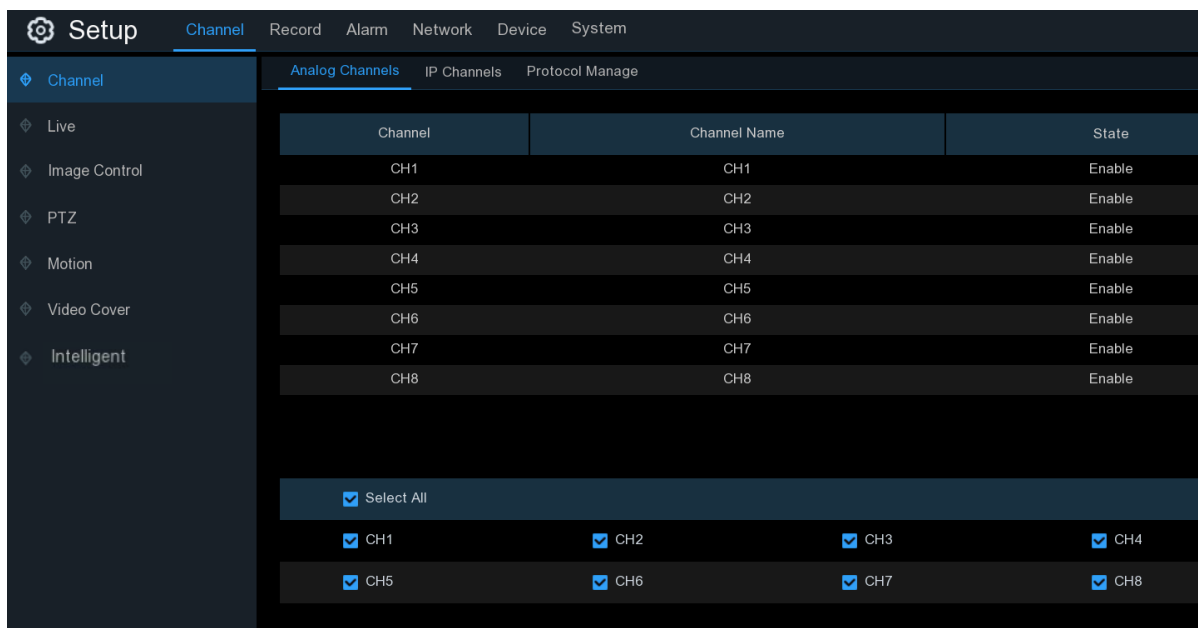

5.1.1.1 Analog Channels

The DVR supports to disable analog channels to increase IP channels. If you want to disable an analog channel, uncheck the box and click **Apply** to save. To disable an analog channel can increase an IP channel input. To do so, you need to enable the XVR mode in advance at **System** → **General** → **Mode**, view more on [5.6.1 General](#).

5.1.1.2 IP Channels

If you enable the XVR mode for the DVR, it supports to add IP cameras & modify IP channels.

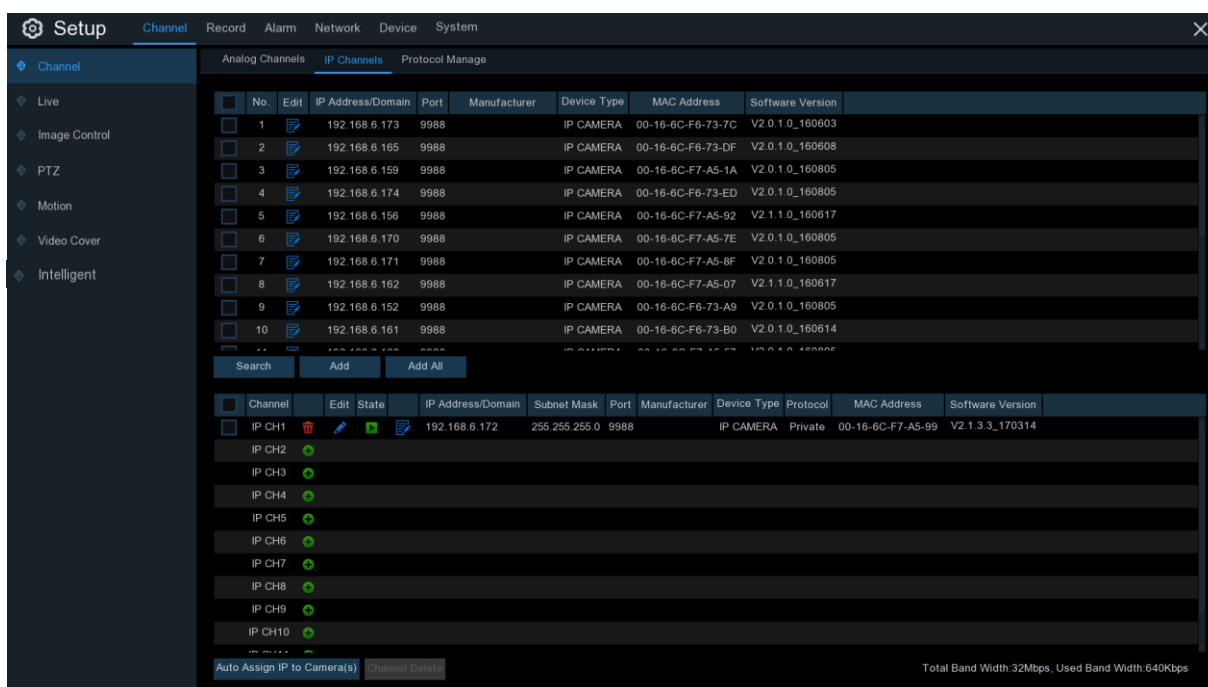

Click **Search** to search IP cameras from local network, click **Add** to add individual IP camera, click **Add All** to add all IP cameras.

The screenshot shows a configuration form for adding an IP camera. The fields are as follows:

- IP Address/Domain:** 192.168.1.151
- Alias:** CH17
- Position:** Left-Top (dropdown menu)
- Port:** 9988
- Protocol:** Private (dropdown menu)
- User Name:** admin
- Password:** (empty field) with a Show Password checkbox to the right.
- Bind channel:** CH17 (dropdown menu)

At the bottom of the form, there are three buttons: **Search**, **Add**, and **Cancel**.

Click **Search** button to search IP cameras, and then click one of the IP camera in the device list.

IP Address/Domain: IP address or domain name of the IP camera

Alias: Name of the IP camera

Position: Position to display the camera name on the screen.

Port: Port of the IP camera

Protocol: Choose the protocol of the IP camera from the dropdown menu

User Name: User Name of the IP camera

Password: Password of the IP camera

Bind channel: Choose a channel of the DVR you want to attach to

Auto Assign IP to Camera(s): The added IP camera would be not able to connect if its IP address is not in the same network segment with DVR. With this function to reassign an IP address to all added IP cameras.

Channel Delete: Choose one or more added IP cameras, and click this button to delete.

5.1.1.3 Protocol Manage

With the Protocol Manage, you can edit your own RTSP protocol for IP camera connection.

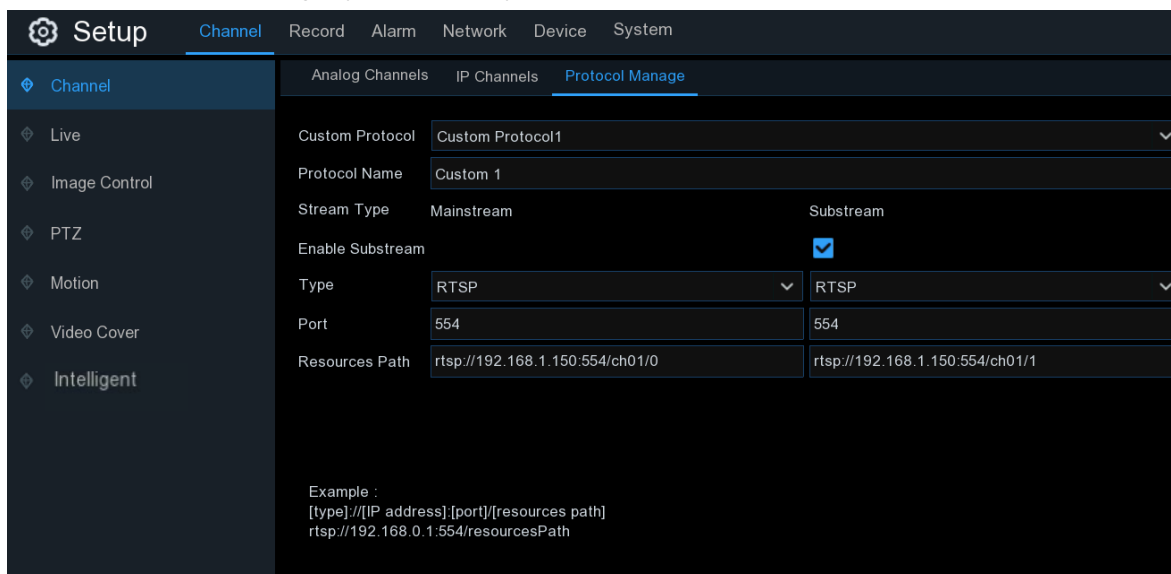

Custom Protocol: The system support max. 10 custom protocol options.

Protocol Name: To give a name to your custom protocol.

Enable Substream: Check the box if you want to enable sub-stream.

Type: Only RTSP available now.

Port: Input the RTSP port of your IP camera.

Resources Path: Input the RTSP address of your IP camera.

5.1.2 Live

To configure camera parameters.

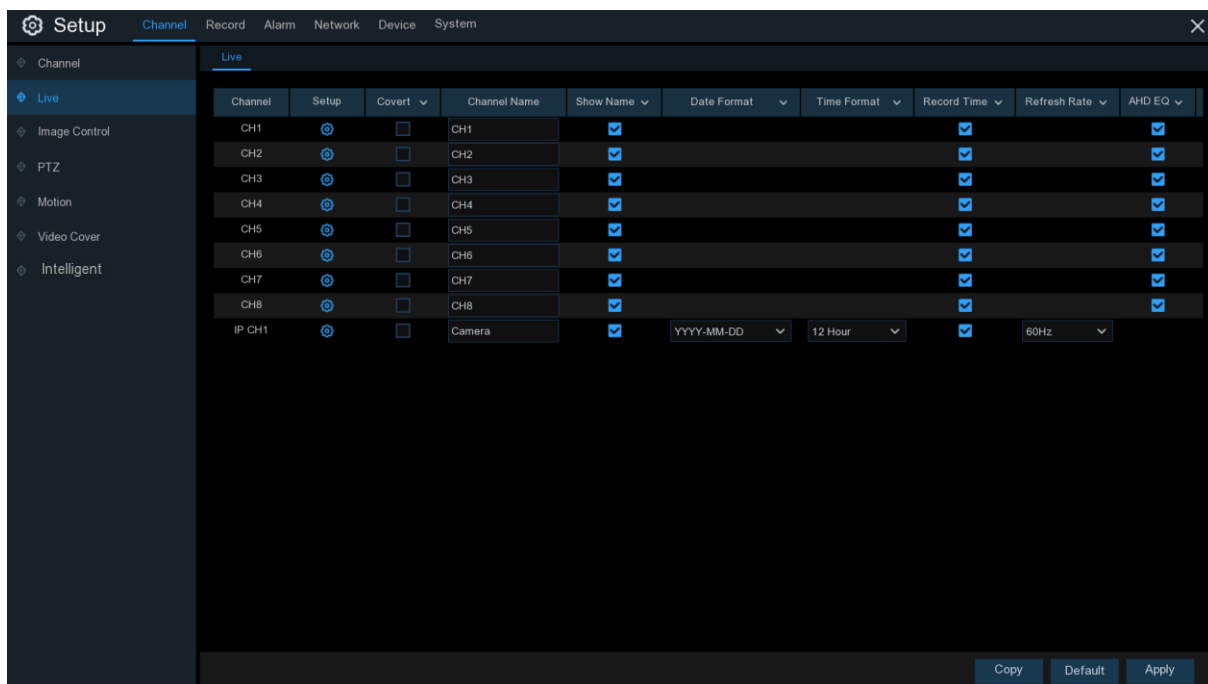

Channel: Display channel name.

Setup: Click  icon into the setup page.

- Channel: CH17 → Choose a channel to configure
- Channel Name: IP CH17 → Give a name to the camera
- Date Format: MM/DD/YYYY → Date format to display for the camera (for IP camera only)
- Time Format: 24 Hour → Time format to display for the camera (for IP camera only)
- Refresh Rate: 50Hz → Refresh Rate of the camera (for IP camera only)
- Camera Type: AUTO → Choose a camera type (Auto, AHD, TVI, CVI) for analog camera
- EQ Level: AUTO → Choose an AHD EQ (Enhanced Quality) level depends on your camera video cable
- Convert → Check the box If you want to hide the live image of this channel
- Show Name → To show the camera name in live view screen
- Show Time → To show the system time in live view screen
- HUE: 32 → Adjust the Hue value for the image color
- BRIGHT: 23 → Adjust the Bright value for the image color
- CONTRAST: 27 → Adjust the Contrast value for the image color
- SATURATION: 20 → Adjust the Saturation value for the image color

Click **Default** to load default settings, click **Apply** to save settings, click right buttons of your mouse to exit.

5.1.3 Image Control

This menu allows you to control image settings for supported IP cameras.

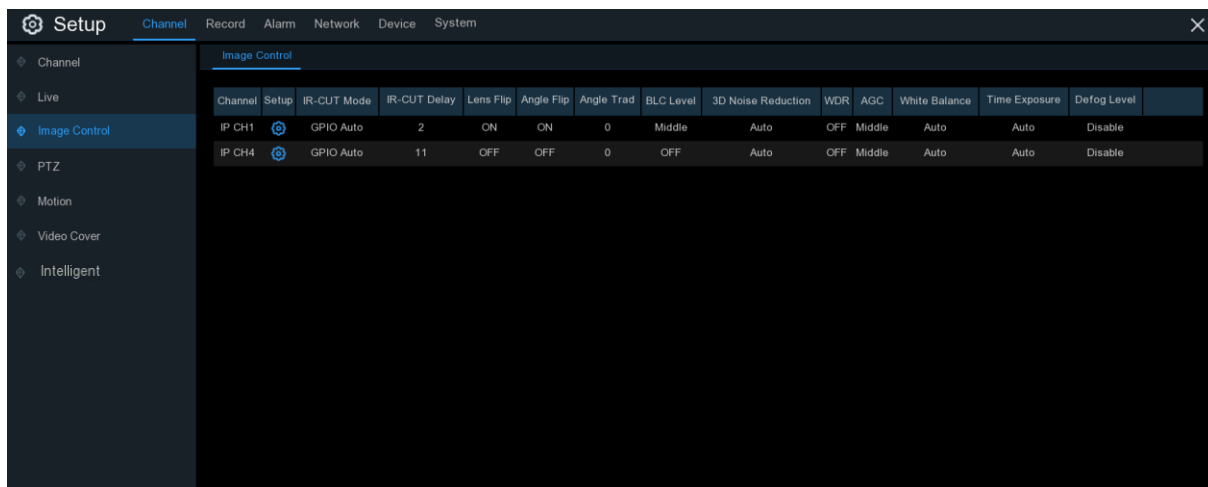

Channel: Channel name.

Setup: Click  icon into the setup page.

Channel	CH17	Choose a channel to configure
IR-CUT Mode	GPIO Auto	Select the desired built-in IR cut filter mode to ensure the camera works properly both in the day and night.
IR-CUT Delay	2	Set the delay time of IR-CUT switching
<input type="checkbox"/> Lens Flip	<input type="checkbox"/> Angle Flip	Check to enable lens flip and angle flip
Angle Trad	0	Set the flip angle
Back Light	Enable	To enable or disable Backlight compensation
BLC Level	Low	Choose the backlight compensation level
3D Noise Reduction	Auto	To enable or disable 3D noise reduction function
Level	128	Set the 3D noise reduction level
WDR	Enable	Enable to allow automatically adjust the brightness and contrast of the video when shooting in the darkness with bright light sources.
Level	128	Set the WDR level
AGC	Middle	Automatic Gain Control
White Balance	Auto	Configure white balance
Shutter	Auto	Set the shutter mode
Time Exposure	1/8	Choose the exposure time of the camera
Defog Mode	Auto	Use in foggy environments to improve the video quality

5.1.4 PTZ

This menu allows you to configure the PTZ (Pan-Tilt-Zoom) settings for the dome camera

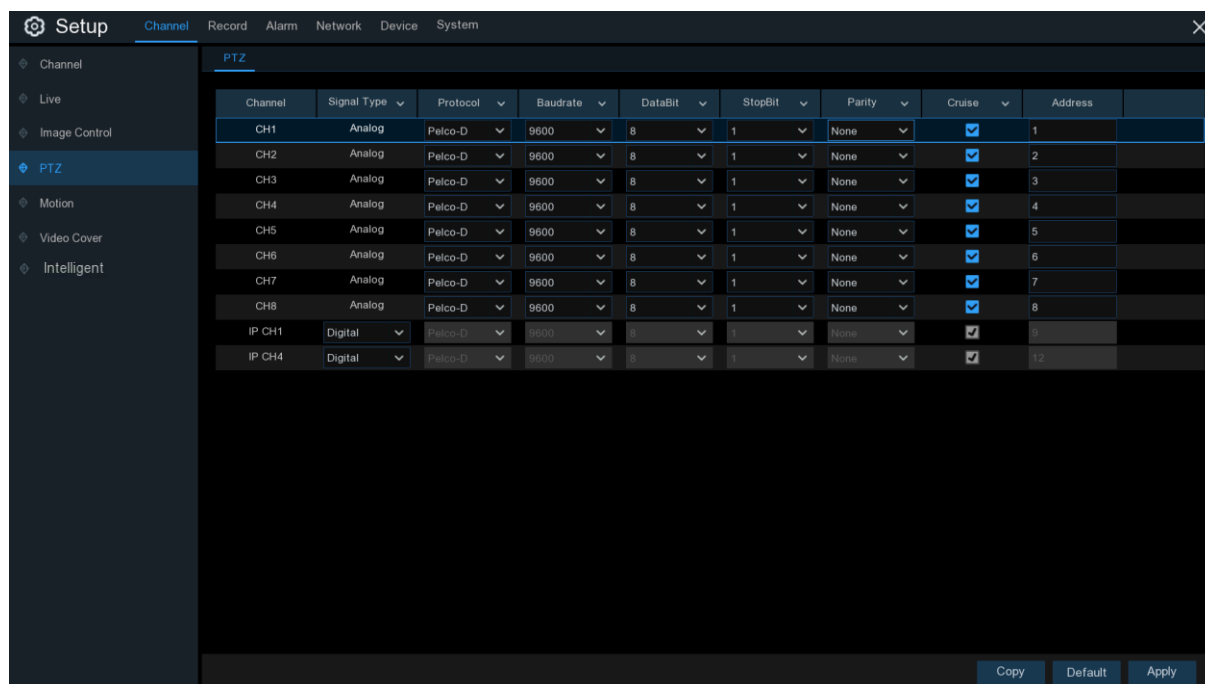

Channel: Channel name

Signal Type: Analog for analog channels, Analog & Digital for IP channels.

Protocol: Choose the communication protocol between the PTZ capable camera and DVR. If your camera support UTC (Up the Coax) function, you can choose COAX1 or COAX2 to display your camera OSD menu or control the UTC PTZ function.

Baudrate: The speed of the information sent from the DVR to the PTZ-capable camera. Make sure it matches the compatibility level of your PTZ-capable camera.

DataBit / StopBit: The information between the DVR and PTZ-capable camera is sent in individual packages. The **DataBit** indicates the number of bits sent, while the **EndBit** indicates the end of the package and the beginning of the next (information) package. The available parameters for **DataBit** are: **8, 7, 6, 5**. the available parameters for the **StopBit** are **1** or **2**.

Parity: For error check. See the documentation of your PTZ-capable camera, to configure this setting.

Cruise: Enable to use the Cruise mode. In order to use the Cruise mode, you need to set a number of preset points.

Address: Set the command address of the PTZ system. Please be noted that each PTZ-capable camera needs a unique address to function properly

5.1.4.1 PTZ control

After finishing the PTZ setup, you can use the PTZ function to control your PTZ camera.

- 1) Click left your mouse upon a channel on Live Viewing screen to open [Camera Quick Toolbar](#), and choose the PTZ control icon .

2) PTZ control panel will be displayed.

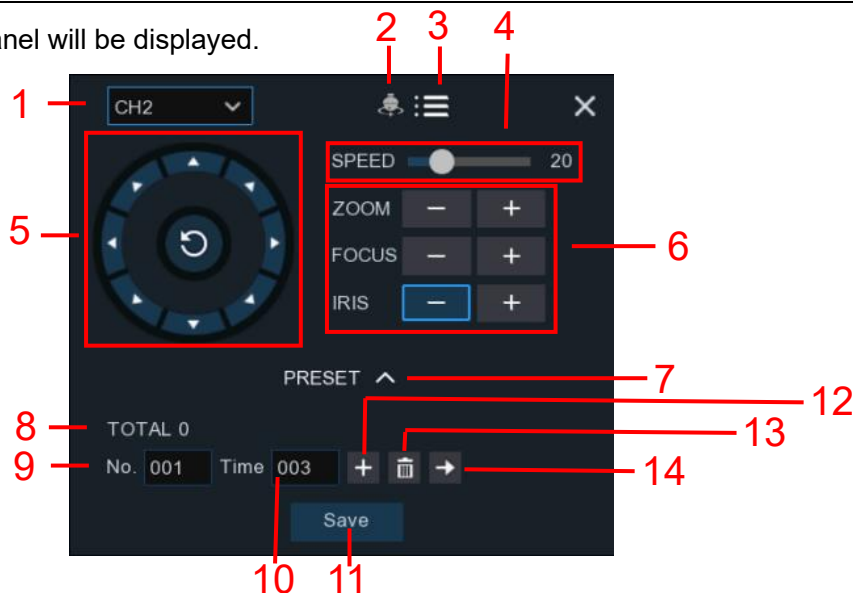

No.	Icon	Item	Description
1		Channel	Click to select the channel of the PTZ camera.
2		Cruise	Start / stop PTZ cruise by preset points. Make sure you had enable the Cruise function for this channel in 5.1.4 PTZ .
3		UTC Menu	If you have chosen protocol for this channel as COAX1 or COAX2, the UTC menu button will be display. Click this icon to enter UTC OSD menu. It is also the confirm button for your selection in the UTC OSD menu.
4		Speed	Adjust the PTZ speed
5		Pointer Panel	A) Click the direction arrow to select the direction of the PTZ camera B) Click up/down/left/right arrow to move cursor in UTC OSD menu C) Click to switch to auto pan mode
6	- ZOOM +	Zoom	Click to zoom in/out.
	- FOCUS +	Focus	Click to adjust the focus
	- IRIS +	Iris	Click to adjust the iris setting
7		PRESET	To display or hide the preset point panel
8	Total	Total	Display the total number of preset points
9	No.	No.	Number of preset point
10	Time	Time	Set the time how long the camera will stay in the preset point
11	Save	Save	Click to save the settings and preset points
12		set	Enter the number of a specific preset point, click this button to move your PTZ camera to the preset point
13		Delete	Click to delete the selected preset point
14		Go to	Click to set a specific preset point on a PTZ camera. You can add up to 255 preset points for the DVR.

5.1.5 Motion

This menu allows you to configure motion parameters. When motion has been detected by one or more cameras, your DVR will alert you to a potential threat at your home. It does this by sending you an email alert with an attached image from the camera to use as a reference (if this option is enabled) and/or sending push notifications via the mobile app.

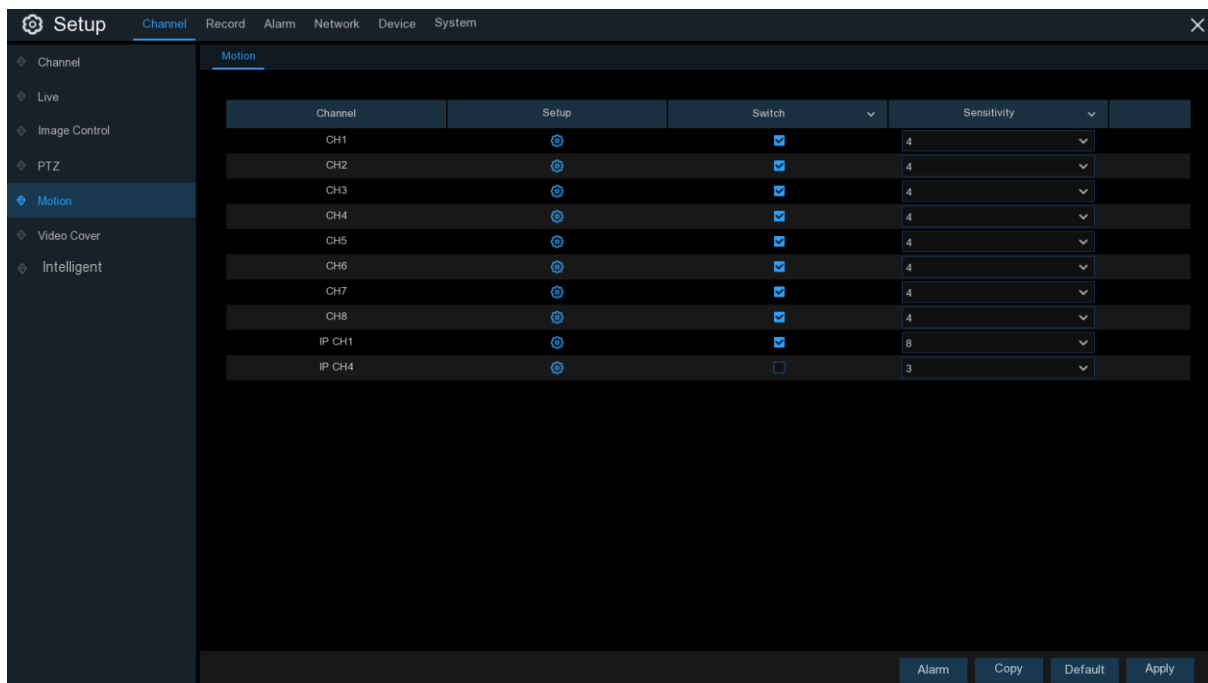

Setup: Click icon into the setup page.

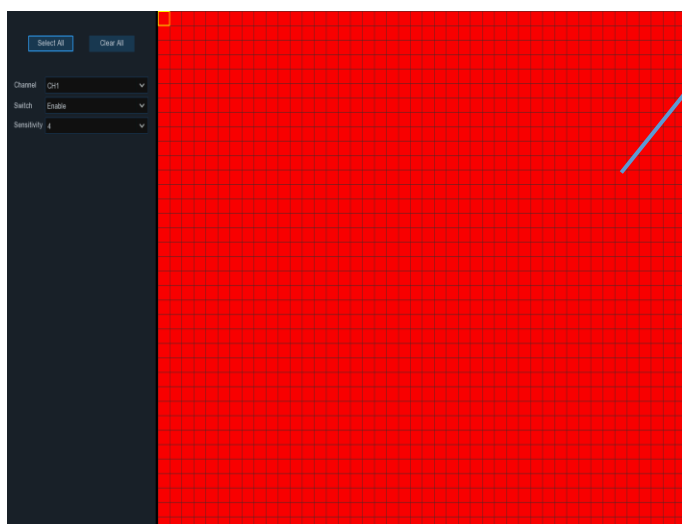

Motion Detection Area:

The whole screen is marked for motion detection (red blocks) as default. If you want to disable the motion detection on a certain area, click the grid cursor and then drag the mouse to highlight the scope to unmark the area into transparent blocks. After setting is completed, click the right button of your mouse to return and click **Save** to make the area setup effective.

Switch: Enable or disable motion detection.

Sensitivity: Set the sensitivity level. Level 1 the lowest sensitivity level while level 8 is the highest sensitivity level.

Click **Alarm** button to configure the motion detection alarm function:

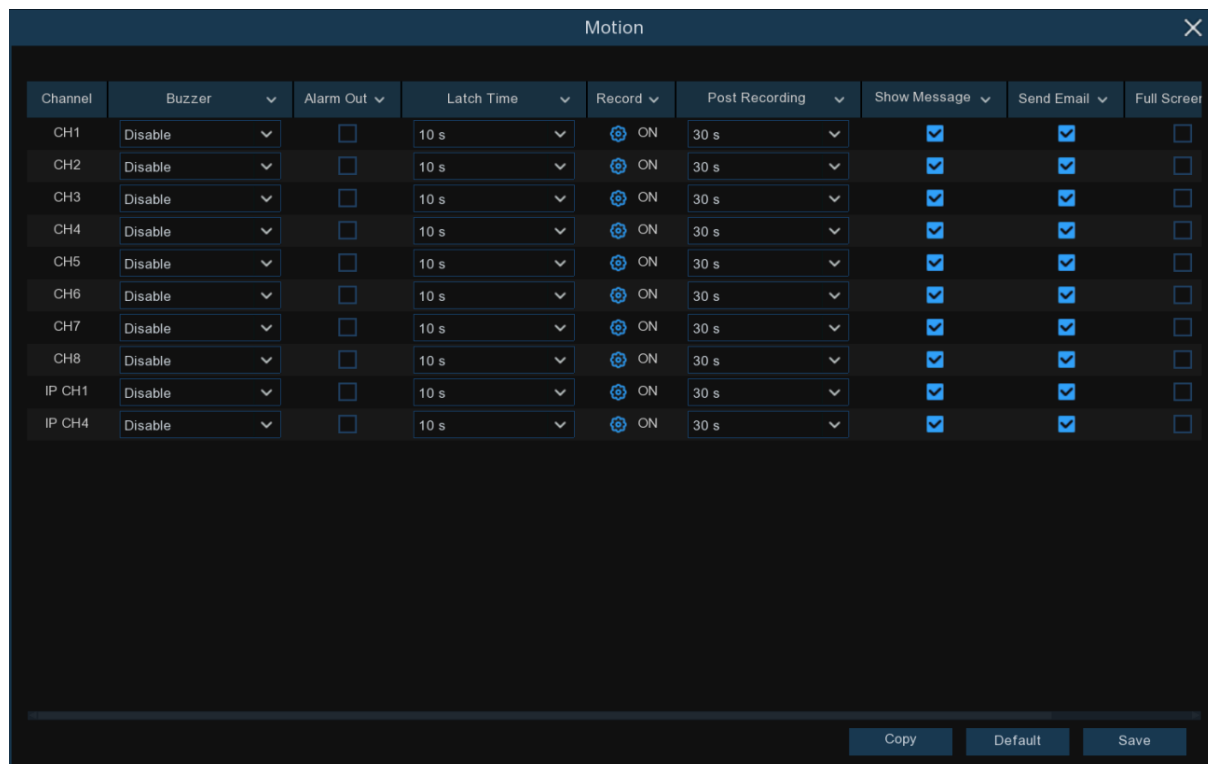

Buzzer: The DVR can use its internal buzzer to emit an alarm tone. You can set the buzzer duration in seconds when the motion is detected.

Alarm Out: Optional function. If your DVR support to connect to external alarm device, you can set to emit an alarm tone.

Latch Time: To configure the external alarm time when motion is detected.

Record: Click icon and choose which channel(s) you want to record when the motion 5.detection is triggered.

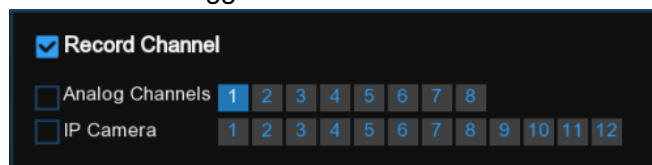

Post Recording: You can set how long after an event occurs that the DVR will continue to record. The recommended recording length is 30 seconds but it can be set higher up to 5 minutes.

Show Message: Check the box to display icon on the live view screen when the motion is detected.

Send Email: You can let the DVR to send you an auto-email when the motion is detected.

Full Screen: If this function is enabled and a motion is detected in a channel, you will see that channel in full screen.

FTP Upload: To upload alarm images to FTP server when motion is detected. To enable FTP, please view [5.4.4 FTP](#).

5.1.6 Video Cover

This menu allows you to create privacy zone(s) if you want to partially cover some certain part of the image. You can create up to 4 privacy zones in any size and location on the camera image. Enable the Privacy Zone, and choose how many zones you need. The zone(s) appear as “red box”. Click the edge of the red box and drag it to any size to create a privacy zone.

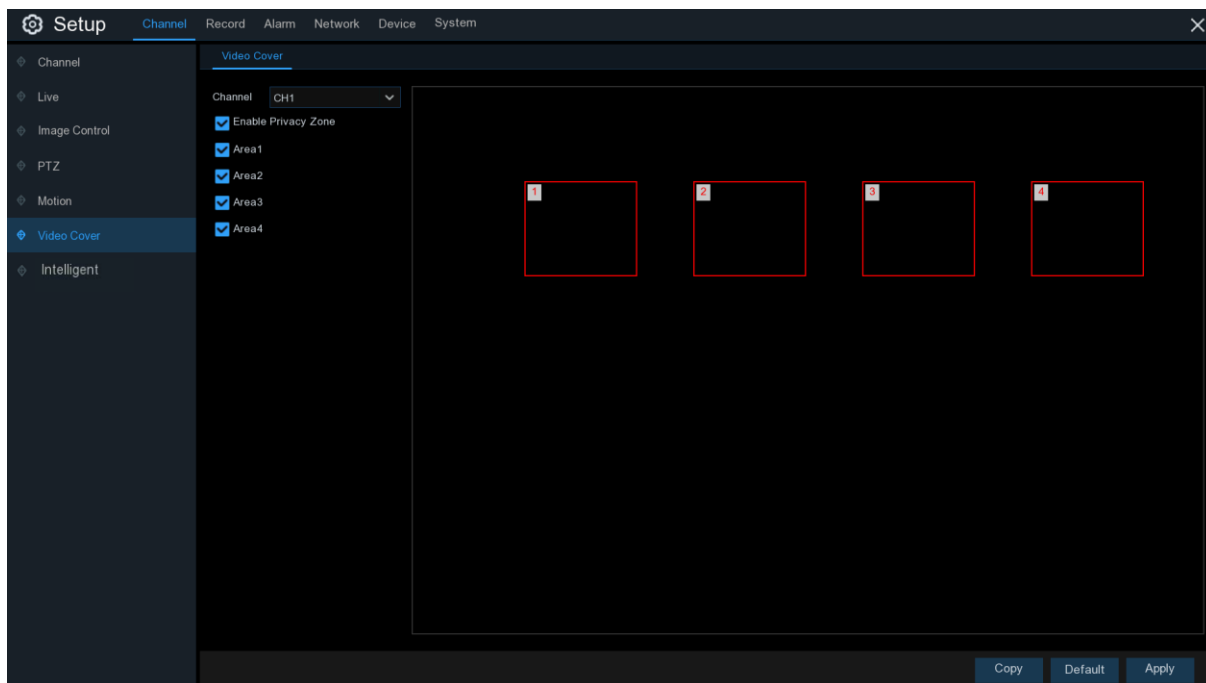

Note: The area of privacy zones you had set will be invisible in both live view & recording video.

5.2 Record

This menu allows you to configure the recording parameters

5.2.1 Encode

This menu allows you to configure the recording video or network transmission picture quality. Generally, Mainstream defines the recording video quality which will be saved in the HDD; Substream defines the video quality which is being viewed via remote access, for example web client & CMS; Mobilestream defines the video quality which is being viewed via remote access via mobile devices.

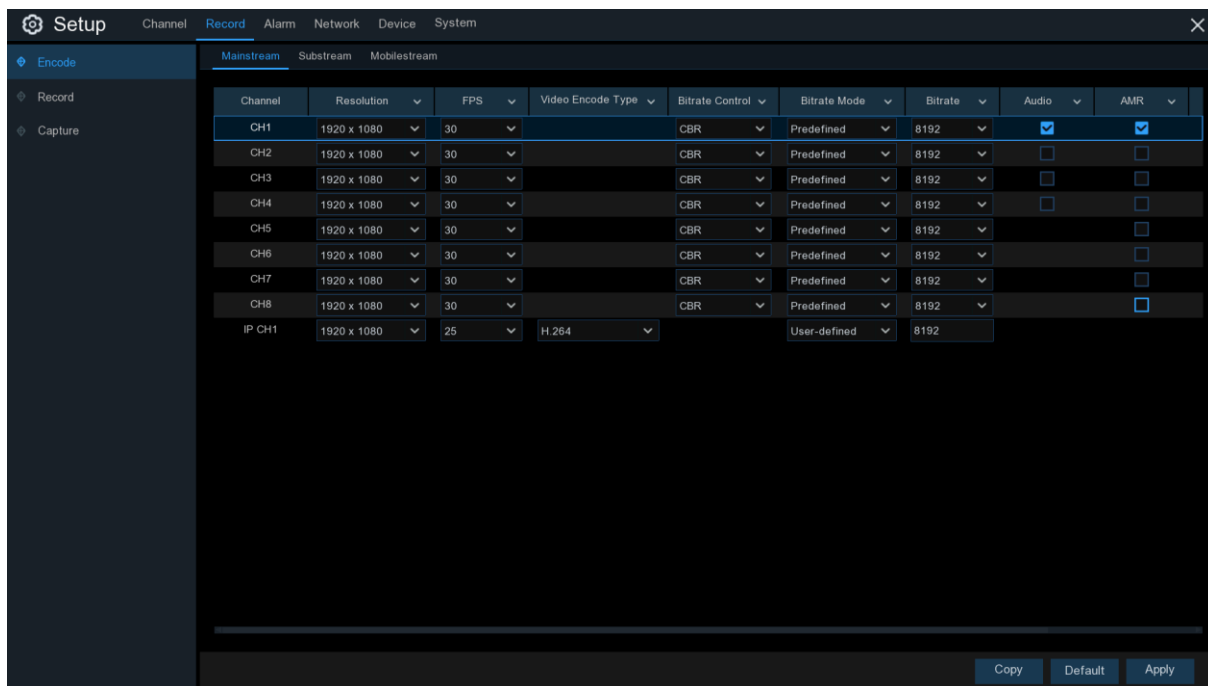

Resolution: This parameter defines how large the recorded image will be.

FPS: This parameter defines the number of frames per second the DVR will record.

Video Encode Type: For IP camera only. DVR support H.264 IP camera only. If you choose H.265, live view screen of the IP channel will display “[Decoding Failed](#)”.

Bitrate Control: Select the bitrate level. For a simple scene, such as a gray wall is suitable constant bitrate (**CBR**). For more complex scene, such as a busy street is suitable variable bitrate (**VBR**).

Bitrate Mode: If you want to set the bitrate by yourself, then choose **User-defined** mode. If you want to select the predefined bitrate, choose **Predefined** mode.

Bitrate: This parameter corresponds to the speed of data transfer that the DVR will use to record video. Recordings that are encoded at higher bitrates, will be of better quality.

Audio: Select this option if you want to record audio along with video and have a microphone connected to the DVR or using a camera with audio capability.

AMR: If AMR option is checked, this channel will be recorded in maximum frame rate & bitrate when an alarm (motion or I/O alarm) happens to this channel.

5.2.2 Record

This menu allows you to configure the channel recording parameters.

5.2.2.1 Record

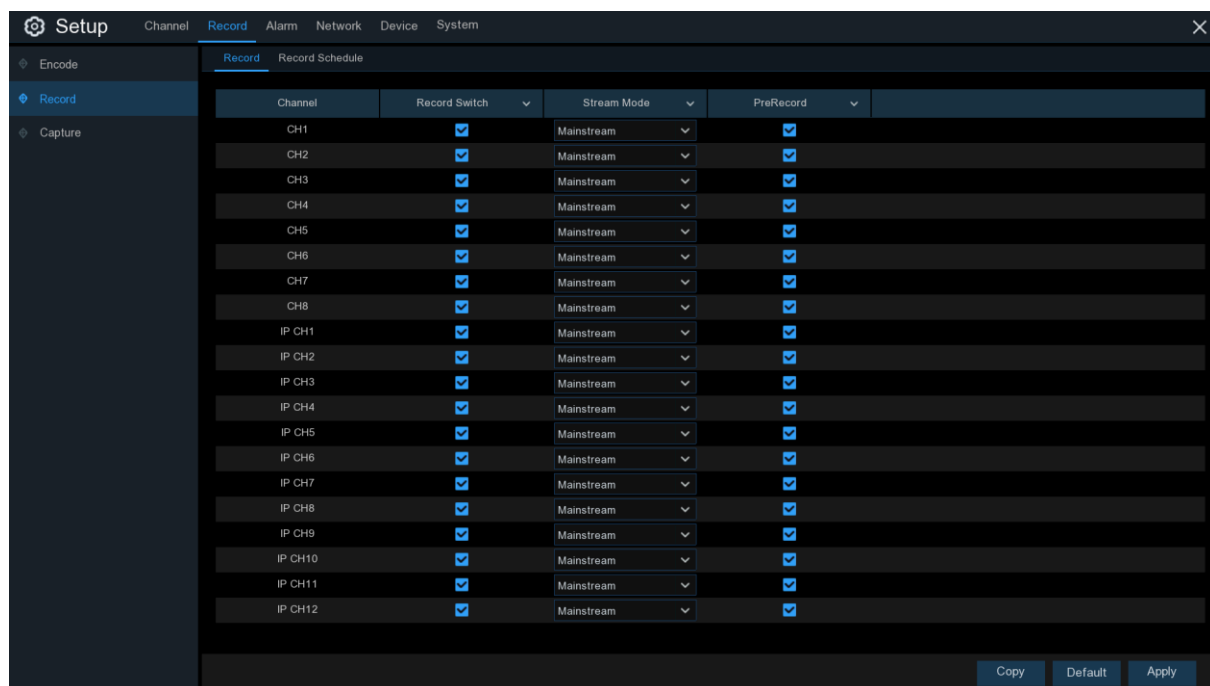

Record Switch: Check to enable the recording in this channel.

Stream Mode: Choose the recording quality. If you choose Dualstream, the system will record in both Mainstream & Substream.

PreRecord: If this option is enabled, the DVR starts recording a few seconds before an alarm event occurs. Use this option if your primary recording type is motion or I/O alarm based.

5.2.2.2 Record Schedule

This menu allows you to specify when the DVR records video and defines the recording mode for each channel. The recording schedule lets you set up a schedule like, daily and hourly by normal (continuous) recording, motion recording, I/O alarm recording & PIR recording (if your DVR supports). To set the recording mode, click first on the mode radio button (Normal, Motion, IO, PIR), then drag the cursor to mark the slots. The recording schedule is valid only for one channel. If you want to use the same recording schedule for other channels, use **Copy** function. Click **Apply** to save your settings.

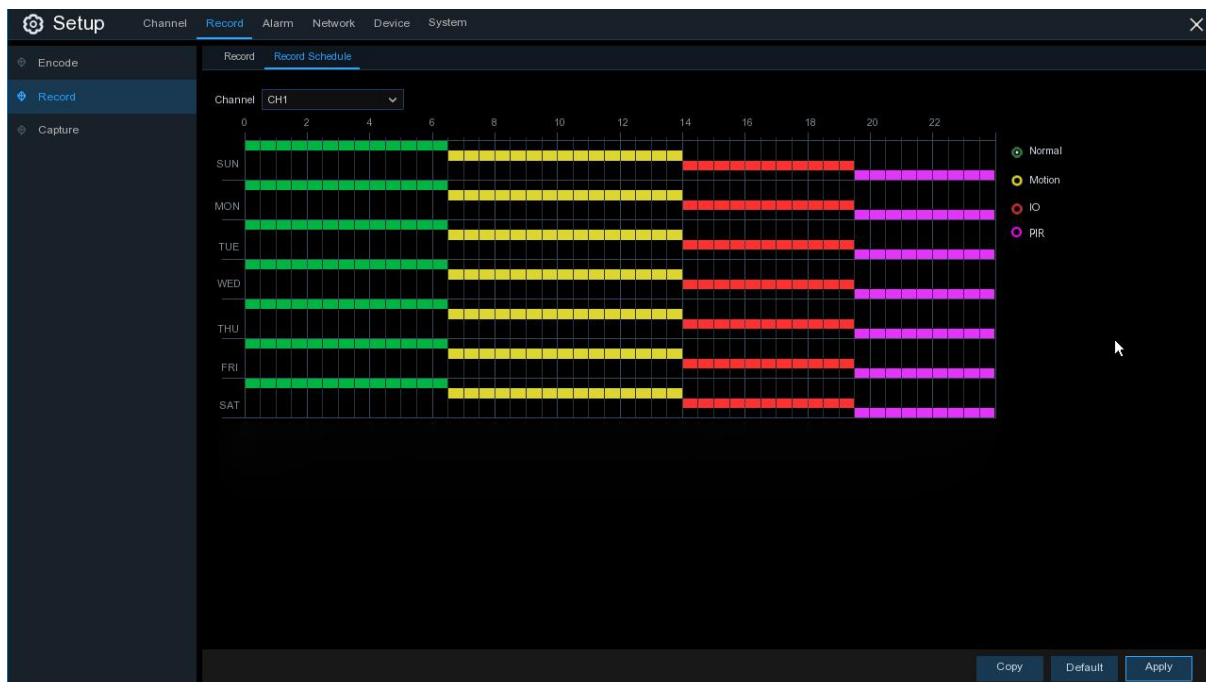

Channel: Select the channel to set its recording parameters.

Normal: When the time slot is marked green, this indicates the channel performs normal recording for that time slot.

Motion: When the time slot is marked yellow, this indicates the channel records only when a motion is detected during that time slot.

IO: When the time slot is marked red, this indicates the channel records only when the sensor is triggered during that time slot.

PIR: When the time slot is marked purple, this indicates the channel records only when the PIR is triggered during that time slot.

No Record: A time slot marked black means that there is no recording scheduled for the time slot.

5.2.3 Capture

This menu allows to configure the image capture function.

5.2.3.1 Capture

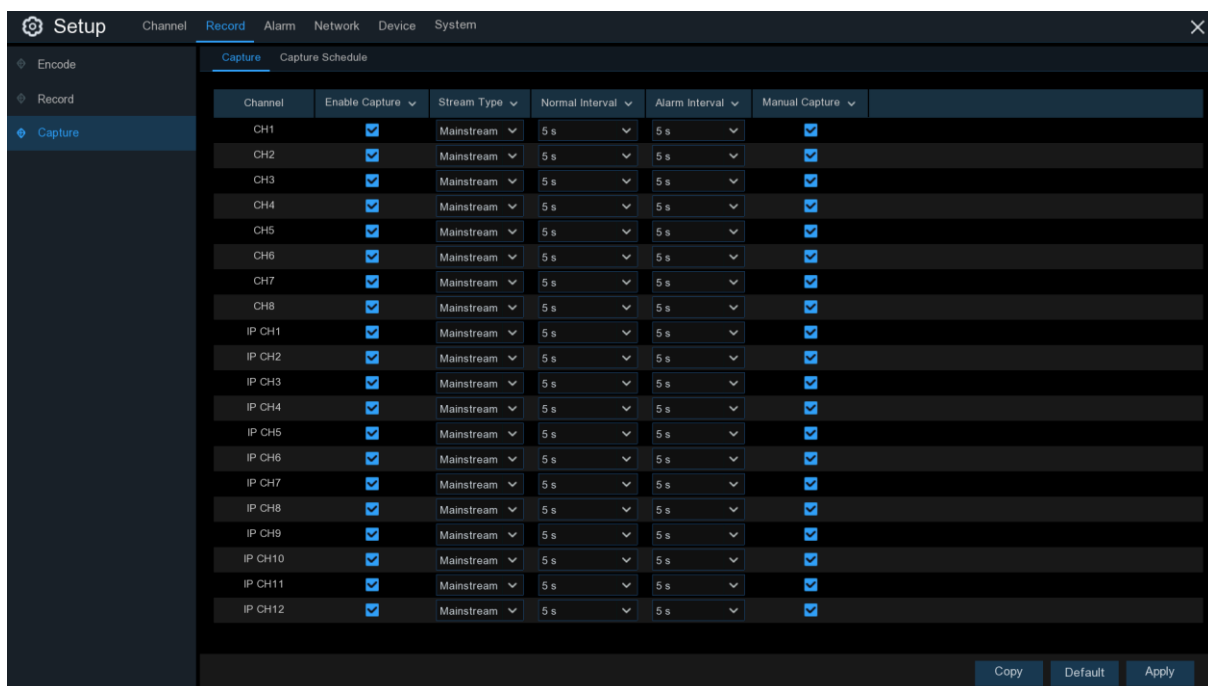

Enable Capture: Enable or disable automatic capturing on the channel.

Stream Type: Select the image resolution by mainstream or substream.

Normal Interval: Time interval to capture an image in normal recording.

Alarm Interval: Time interval to capture an image when motion, IO alarm or PIR is triggered

Manual Capture: Enable or disable manual capture in the channel

5.2.3.2 Capture Schedule



Channel: Select the channel to set its capture parameters.

Normal: When the time slot is marked green, this indicates the channel performs normal capture for that time slot.

Motion: When the time slot is marked yellow, this indicates the channel capture images only when a motion is detected during that time slot.

IO: When the time slot is marked red, this indicates the channel capture images only when the sensor is triggered during that time slot.

PIR: When the time slot is marked purple, this indicates the channel capture images only when the PIR is triggered during that time slot.

No Capture: A time slot marked black means that it won't capture any images for the time slot, but you can manually capture images if you enable the manual capture function in the channel.

5.3 Alarm

In these section, you can configure the alarm parameters.

5.3.1 Motion

Operation is same as [5.1.5 Motion](#)

5.3.2 I/O

This is an optional function, it will appear if your DVR supports sensor I/O, you connect external sensor I/O alarm devices to work with the DVR.

Alarm In	Alarm Type	Buzzer	Alarm Out	Latch Time	Record	Post Recording	Show Message	Send Email	Full Screen
IO-1	Normally-Open	Disable	<input type="checkbox"/>	10 s	ON	30 s	<input checked="" type="checkbox"/>	<input checked="" type="checkbox"/>	<input type="checkbox"/>
IO-2	Normally-Open	Disable	<input type="checkbox"/>	10 s	ON	30 s	<input checked="" type="checkbox"/>	<input checked="" type="checkbox"/>	<input type="checkbox"/>
IO-3	Normally-Open	Disable	<input type="checkbox"/>	10 s	ON	30 s	<input checked="" type="checkbox"/>	<input checked="" type="checkbox"/>	<input type="checkbox"/>
IO-4	Normally-Open	Disable	<input type="checkbox"/>	10 s	ON	30 s	<input checked="" type="checkbox"/>	<input checked="" type="checkbox"/>	<input type="checkbox"/>
IO-5	Normally-Open	Disable	<input type="checkbox"/>	10 s	ON	30 s	<input checked="" type="checkbox"/>	<input checked="" type="checkbox"/>	<input type="checkbox"/>
IO-6	Normally-Open	Disable	<input type="checkbox"/>	10 s	ON	30 s	<input checked="" type="checkbox"/>	<input checked="" type="checkbox"/>	<input type="checkbox"/>
IO-7	Normally-Open	Disable	<input type="checkbox"/>	10 s	ON	30 s	<input checked="" type="checkbox"/>	<input checked="" type="checkbox"/>	<input type="checkbox"/>
IO-8	Normally-Open	Disable	<input type="checkbox"/>	10 s	ON	30 s	<input checked="" type="checkbox"/>	<input checked="" type="checkbox"/>	<input type="checkbox"/>

Alarm In: I/O channel.

Alarm Type: There are 3 types for your choice: Normally-Open, Normally-Close, and OFF. Choose the one to match your sensor type, or choose OFF to close the sensor trigger function.

Buzzer: The DVR can use its internal buzzer to emit an alarm tone. You can set the buzzer duration in seconds when a sensor is triggered.

Alarm out: Tick to enable external alarm device to emit an alarm tone when a sensor is triggered.

Latch Time: you can set how long the buzzer will sound when external sensor is triggered (10s, 20s, 40s, and 60s).

Record: Click icon and choose which channel(s) you want to record when the motion detection is triggered.

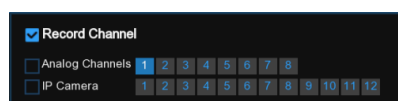

Post Recording: You can set how long alarm record will last when alarm ends (30s, 1minutes, 2minutes, 5minutes).

Show Message: Display the alarm messages on the screen when sensor is triggered.

Send Email: Set to send email to specified email when sensor is triggered.

Full Screen: When sensor is triggered, the corresponding channel will be switched to the full screen mode.

FTP Upload: To upload alarm images to FTP server when I/O alarm is triggered. To enable FTP, please view [5.4.4 FTP](#).

5.3.3 PTZ Linkage

If you had connected the PTZ cameras, you can set the linkage between PTZ cameras and Motion Alarm and/or external I/O sensor alarm. With the linkage function, you can turn your PTZ cameras focus to the preset point when a motion or I/O alarm happens.

Channel	Switch	Motion	IO	PTZ1	PTZ2	PTZ3	PTZ4
CH17	<input checked="" type="checkbox"/>	<input checked="" type="checkbox"/>	<input checked="" type="checkbox"/>	ON	ON	ON	ON
CH18	<input checked="" type="checkbox"/>	<input checked="" type="checkbox"/>	<input checked="" type="checkbox"/>	ON	ON	ON	ON
CH19	<input checked="" type="checkbox"/>	<input checked="" type="checkbox"/>	<input checked="" type="checkbox"/>	ON	ON	ON	ON
CH20	<input checked="" type="checkbox"/>	<input checked="" type="checkbox"/>	<input checked="" type="checkbox"/>	ON	ON	ON	ON
CH21	<input checked="" type="checkbox"/>	<input checked="" type="checkbox"/>	<input checked="" type="checkbox"/>	ON	ON	ON	ON
CH22	<input checked="" type="checkbox"/>	<input checked="" type="checkbox"/>	<input checked="" type="checkbox"/>	ON	ON	ON	ON

Switch: Enable or disable the PTZ linkage function.

Motion: Motion detection alarm will trigger the PTZ linkage function it is checked.

IO: IO alarm will trigger the PTZ linkage function it is checked.

PTZ: Click icon to associate the PTZ cameras with preset points. View preset point at [5.1.4.1](#)

[PTZ control](#).

5.3.4 Exception

This menu allows you to set the type of events that you want the DVR to inform you.

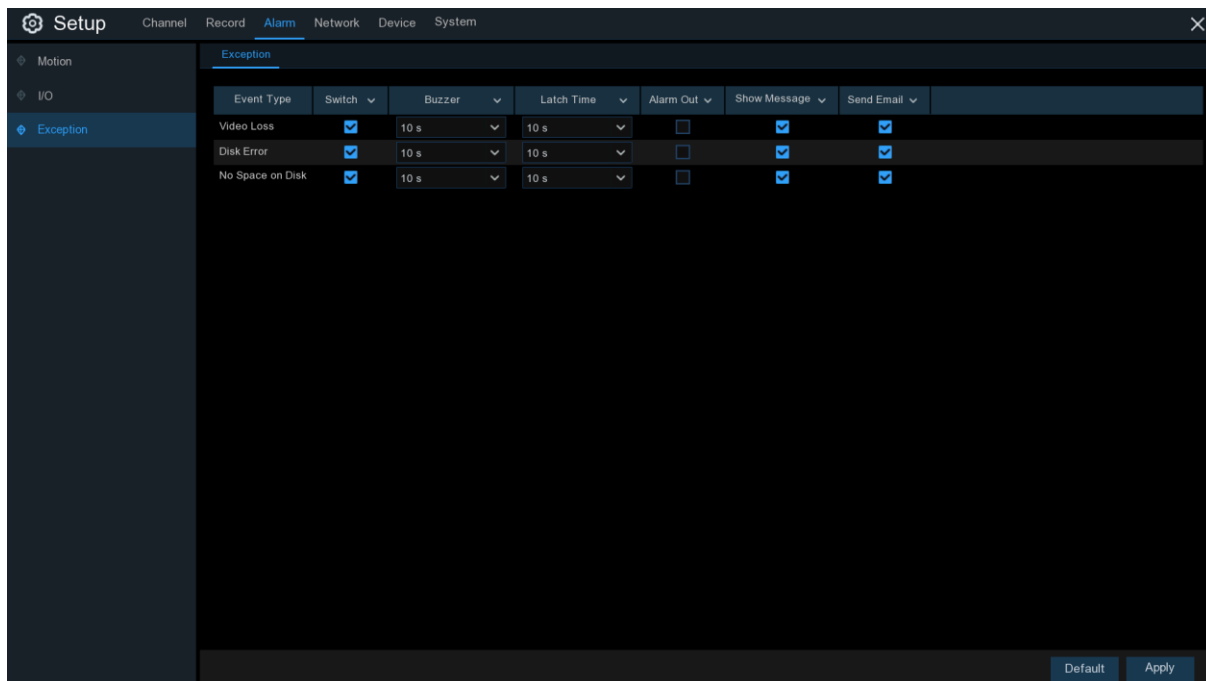

Event Type: Select the event type from below options:

- **No Space on Disk:** When an HDD is full.
- **Disk Error:** If the HDD is not detected properly.
- **Video Loss:** If a camera is not connected properly.

Switch: Check the box to enable the monitoring of the event.

Buzzer: Set the buzzer duration when the event occurs (Off/10s/20s/40s/60s). To disable buzzer, select **OFF**.

Latch Time: This is an optional function. Determine how long the external alarm device to sound (10s, 20s, 40s, 60s) if your DVR support to connect external alarm device.

Alarm Out: This is an optional function. Click to enable the external alarm device to sound. This is an optional function.

Show Message: Check the box to display a message on the screen when No Space on Disk, Disk Error, or Video Loss event happens.

Send Email: Let the DVR to send you an auto-email when an event occurs.

5.4 Network

This menu allows you to configure network parameters, such as PPPoE, DHCP, and 3G. The most common types are DHCP. Most probably your network type is DHCP, unless the network is manually addressed. If you need an authentication user name and password to the Internet, then choose PPPoE.

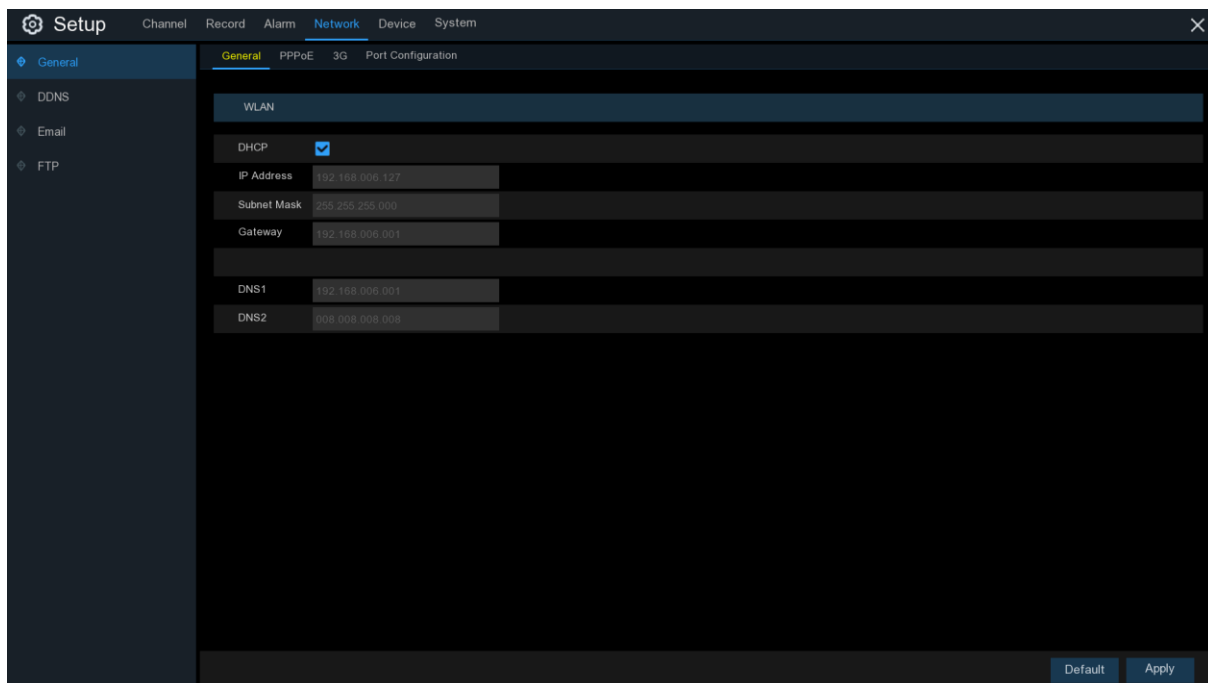

5.4.1 General

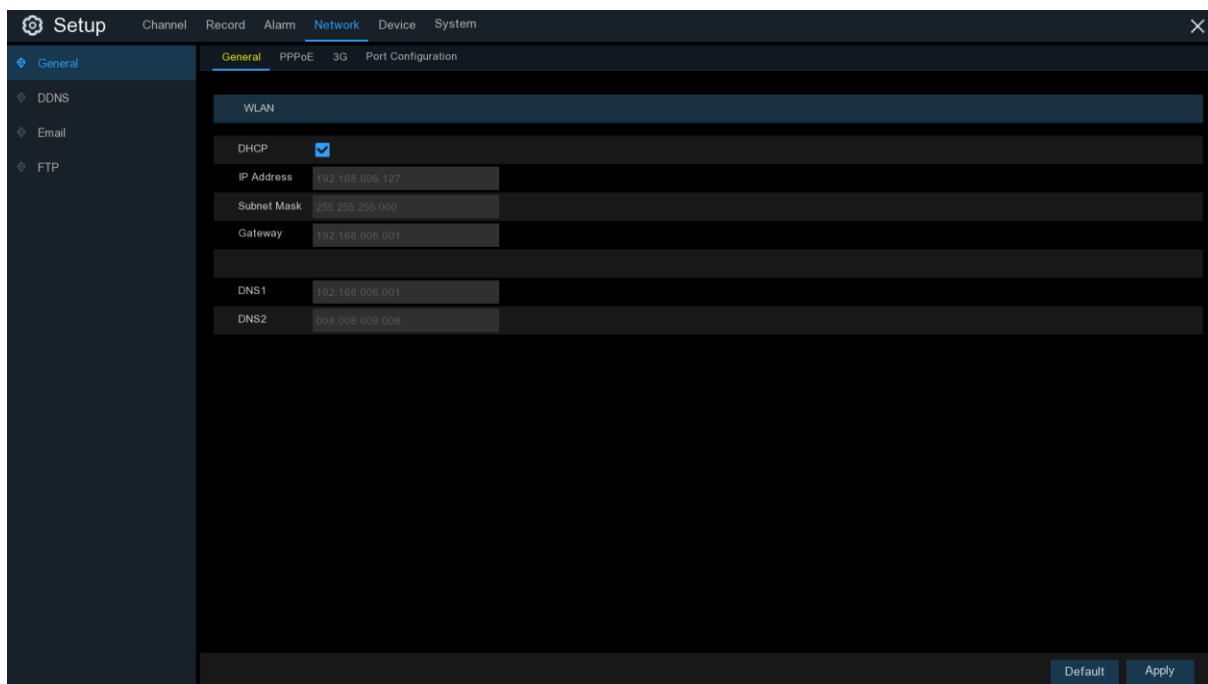

If you connect to a router allows to use DHCP, please check the **DHCP** box. The router will assign

automatically all the network parameters for your DVR. Unless the network is manually addressed below parameters:

IP Address: The IP address identifies the DVR in the network. It consists of four groups of numbers between 0 to 255, separated by periods. For example, “192.168.001.100”.

Subnet Mask: Subnet mask is a network parameter which defines a range of IP addresses that can be used in a network. If IP address is like a street where you live then subnet mask is like a neighborhood. The subnet address also consists of four groups of numbers, separated by periods. For example, “255.255.000.000”.

Gateway: This address allows the DVR to access the Internet. The format of the **Gateway** address is the same as the **IP Address**. For example, “192.168.001.001”.

DNS1/DNS2: DNS1 is the primary DNS server and DNS2 is a backup DNS server. Usually should be enough just to enter the DNS1 server address.

5.4.4.1 PPPoE

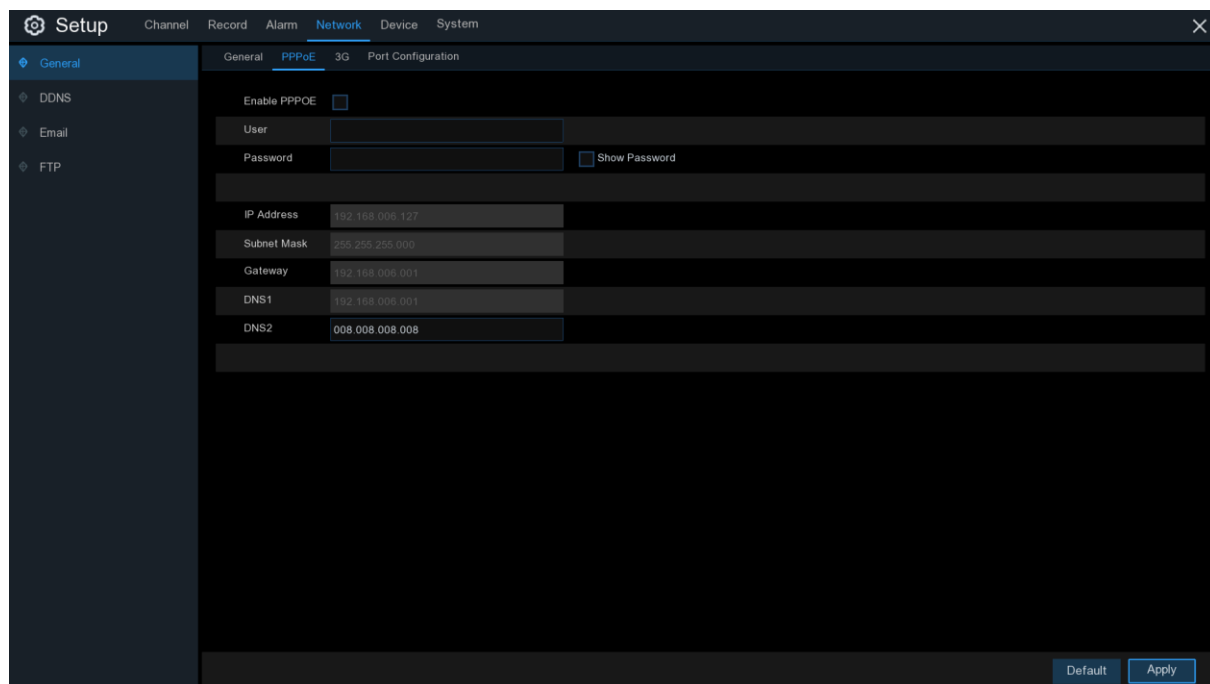

This is an advanced protocol that allows the DVR to connect to the network more directly via DSL modem.

Check the “Enable PPPOE” box, and then enter the User name & Password of the PPPoE.

Click **Apply** to save, system will reboot to activate the PPPoE setting.

5.4.1.2 3G

This is a prior using the mobile network, you need to connect a 3G dongle to the DVR.

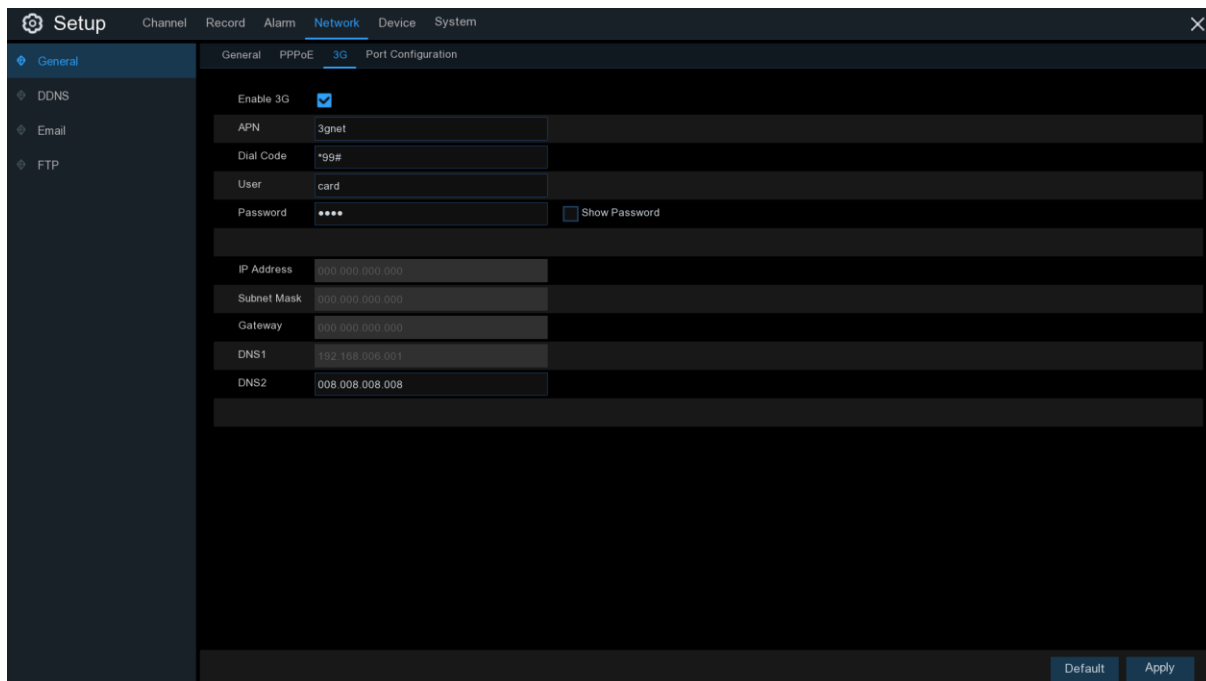

Enable the 3G option, enter the APN, Dial Code, User name & password according to the instruction of your 3G dongle device.

Prior using the mobile network, you need to connect a 3G dongle to the DVR

5.4.1.3 Port Configuration

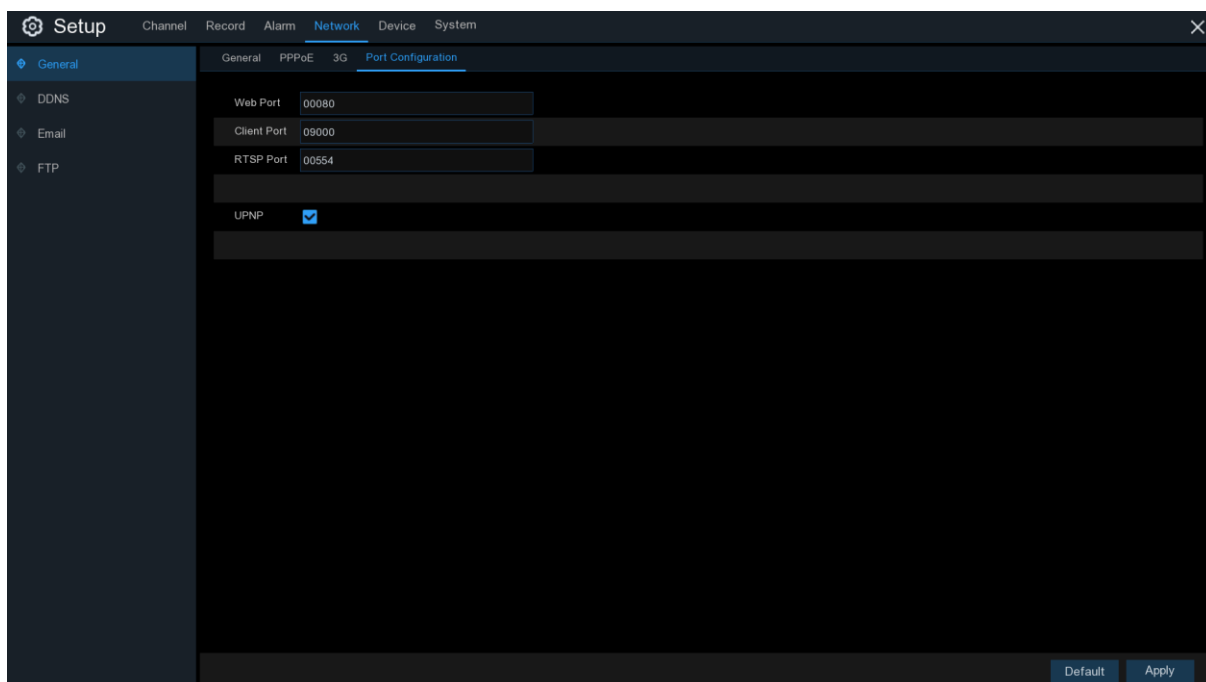

Web Port: This is the port that you will use to log in remotely to the DVR (e.g. using the Web Client). If the default port 80 is already taken by other applications, please change it.

Client Port: This is the port that the DVR will use to send information through. If the default port 9000 is already taken by other applications, please change it.

RTSP Port: Default is 554, if the default port 554 is already taken by other applications, please change it.

UPNP: If you want to log in remotely to the DVR using Web Client, you need to complete the port forwarding. Enable this option if your router supports the UPnP. You need to enable UPnP both, on DVR and router. In this case, you do not need to configure manually port forwarding on your router. If your router does not support UPnP, make sure the port forwarding is completed manually

5.4.2 DDNS

This menu allows you to configure DDNS settings. The DDNS provides a static address to simplify remote connection to your DVR. To use the DDNS, you first need to open an account on the DDNS service provider's web page. For example, KGUARD.ORG: <http://www.kguard.org>.

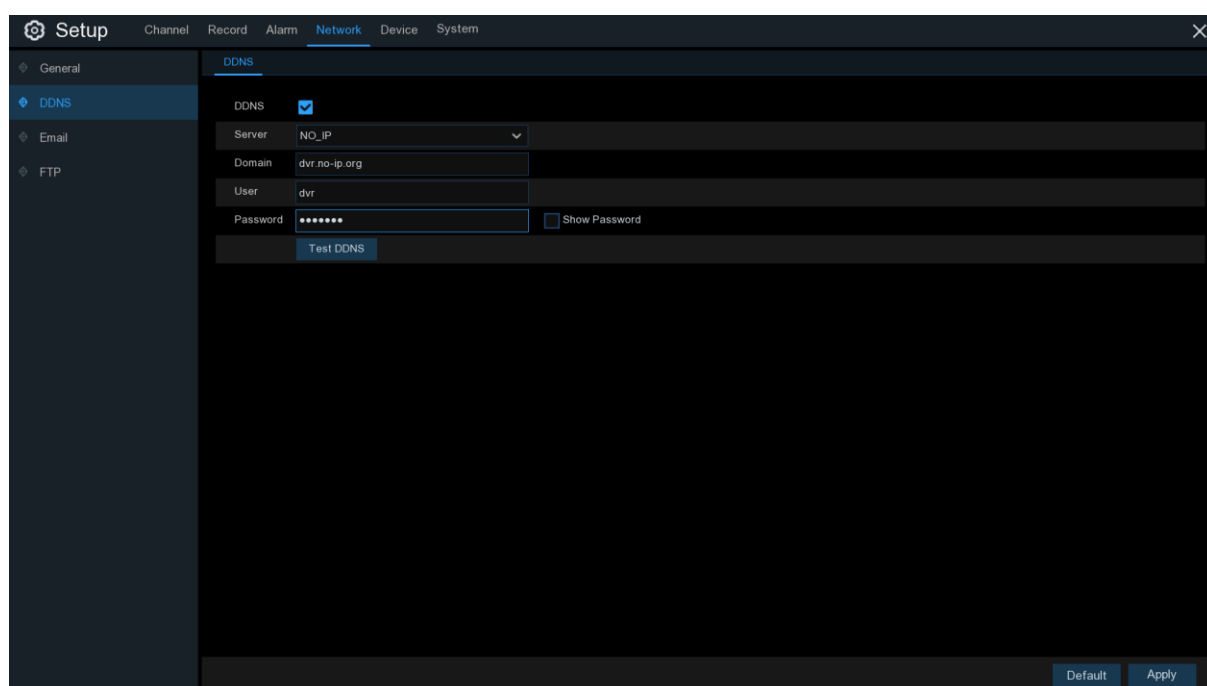

DDNS: Check to enable DDNS.

Server: Select the preferred DDNS server (DDNS_3322, DYNDNS, KGUARD_ORG, NO_IP, CHANGEIP, DNSEXIT).

Domain: Enter the domain name you created on the DDNS service provider's web page. This will be the address you type in the URL box when you want to connect remotely to the DVR via PC. For example: dvr.no-ip.org.

User/Password: Enter the user name and password you obtained when creating an account on the DDNS service provider's web page.

After all parameters are entered, click **Test DDNS** to test the DDNS settings. If the test result is "Network is unreachable or DNS is incorrect", please check whether the network works fine, or the DDNS information is correct or not.

5.4.3 Email

This menu allows you to configure email settings. Please complete these settings if you want to receive the system notifications on your email when an alarm is triggered, HDD becomes full, HDD is in error state, or Video Loss occurs.

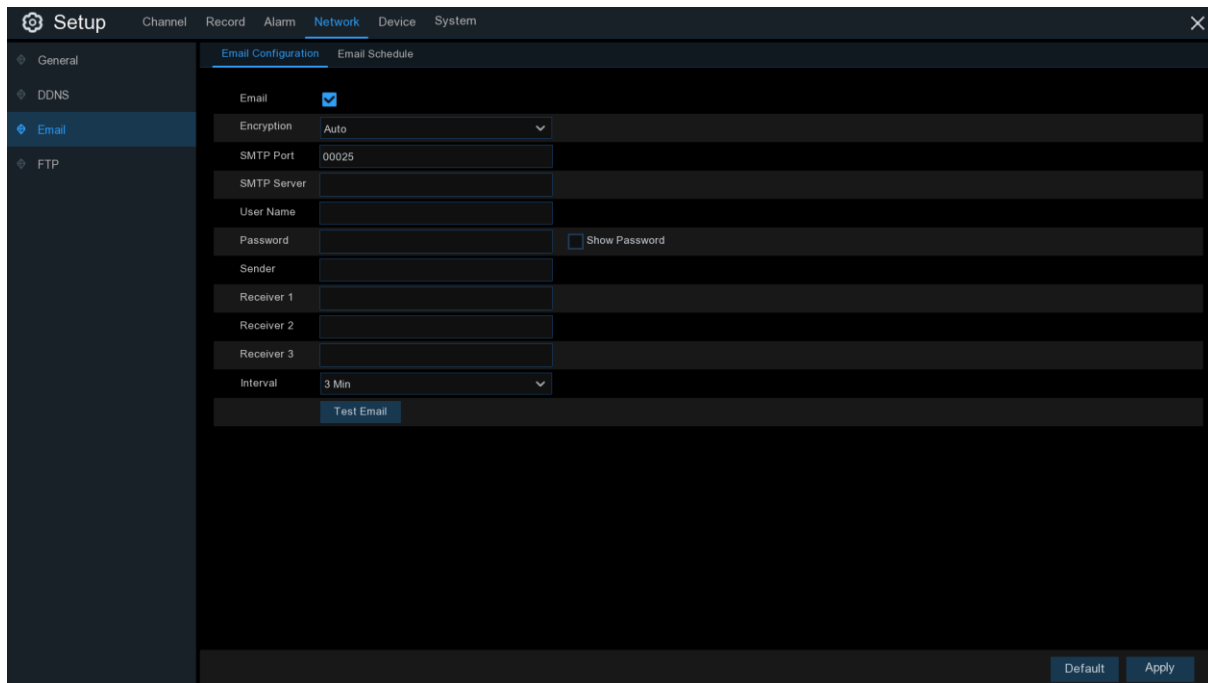

5.4.3.1 Email Configuration

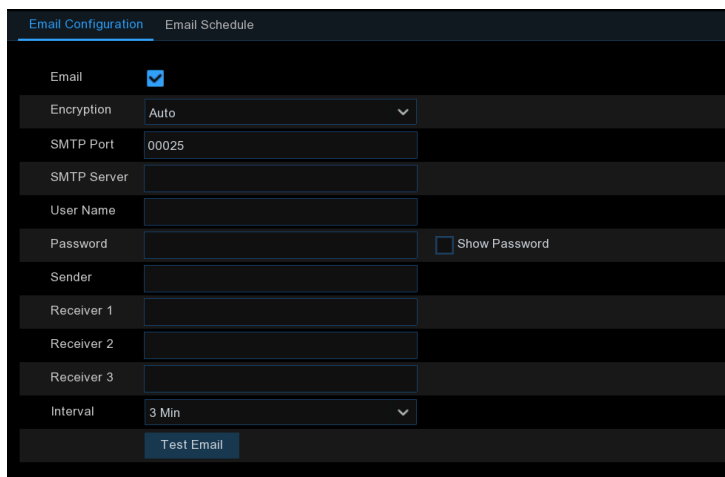

Email: Check to enable.

Encryption: Enable if your email server requires the SSL or TLS verification. If you are not sure, set to be **Auto**.

SMTP Port: Enter the SMTP port of your email server.

SMTP Server: Enter the SMTP server address of your email.

User Name: Enter your email address.

Password: Enter the password of your email.

Receiver 1~3: Enter the email address where you want to receive the event notifications from the DVR.

Interval: Configure the length of the time interval between the notification emails from the DVR.

To make sure all settings are correct, click **Test Email**. The system sends an automated email message to your inbox. If you received the test email, it means the configuration parameters are correct.

5.4.3.2 Email Schedule

You need to configure the schedule to fully implement the Email notification.

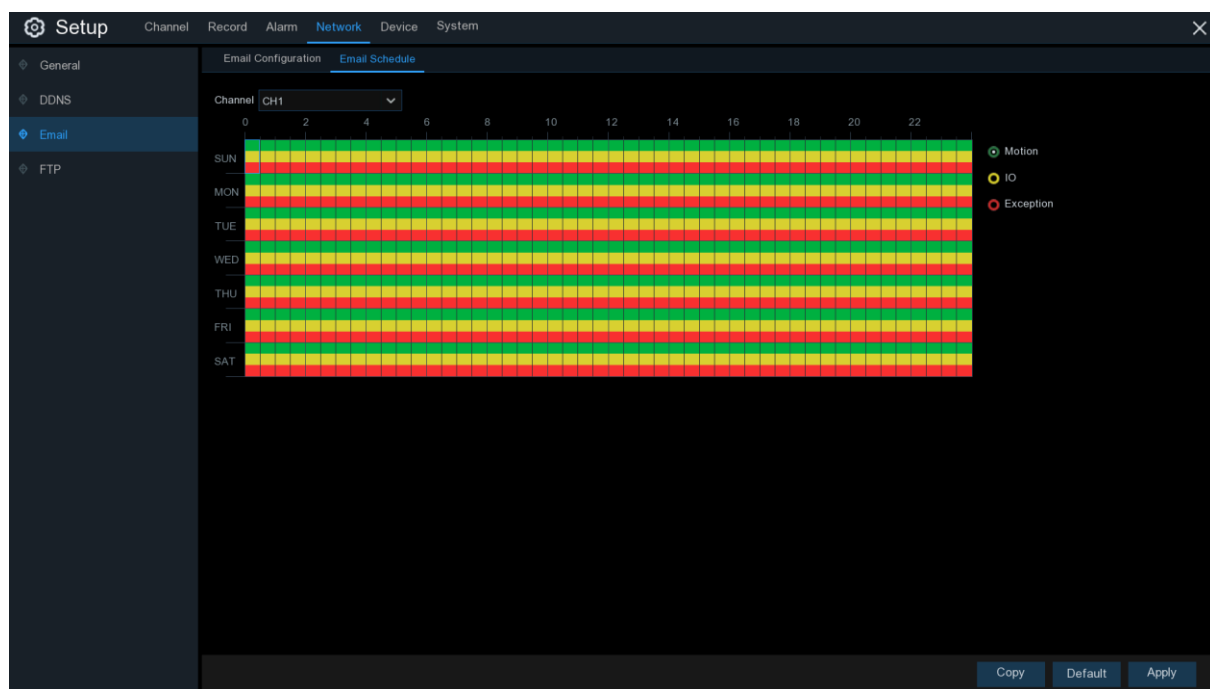

The color codes on email schedule have the following meanings:

Green: Slot for Motion detection.

Yellow: Slot for I/O Alarm (optional).

Red: Slot for Exception (HDD full, HDD error, or Video Loss).

Purple: Slot for PIR (optional).

5.4.4 FTP

This menu allows you to enable FTP function to view and load captured snapshots from DVR to your storage device over FTP.

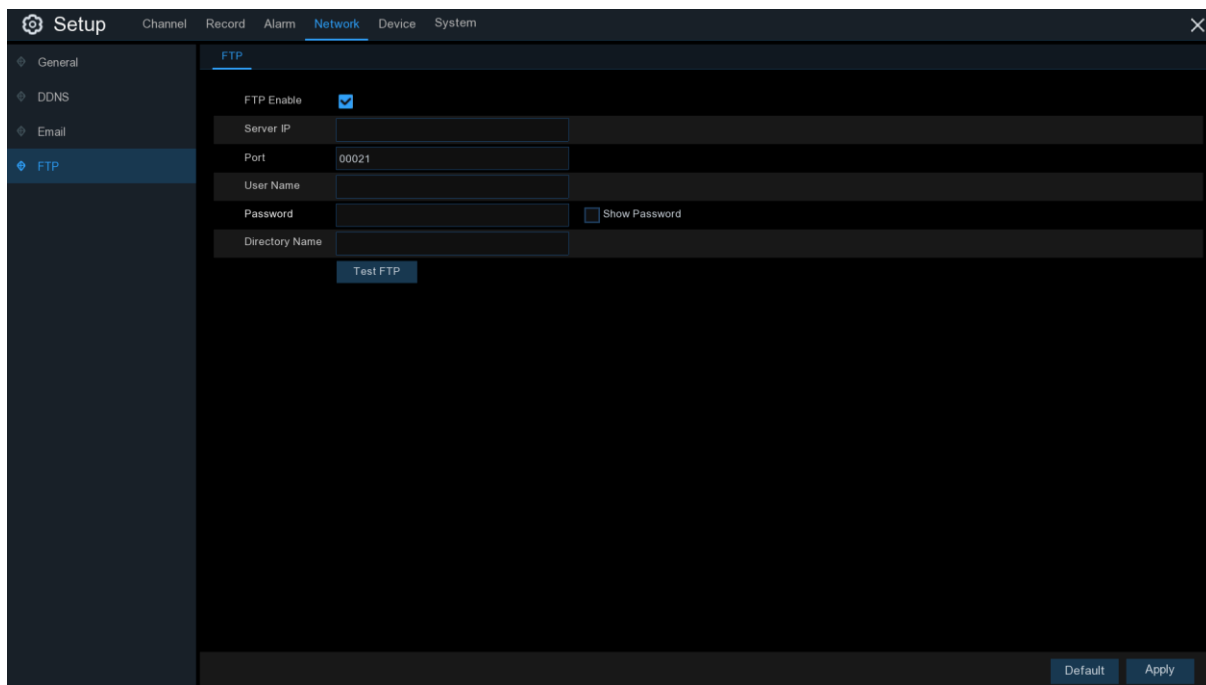

The screenshot shows a web-based configuration interface for a device. The top navigation bar includes 'Setup', 'Channel', 'Record', 'Alarm', 'Network', 'Device', and 'System'. The 'Setup' menu is expanded to show 'General', 'DDNS', 'Email', and 'FTP'. The 'FTP' configuration page is active, showing the following fields and controls:

- FTP Enable:** A checked checkbox.
- Server IP:** An empty text input field.
- Port:** A text input field containing '00021'.
- User Name:** An empty text input field.
- Password:** A text input field with a 'Show Password' checkbox to its right.
- Directory Name:** An empty text input field.
- Test FTP:** A button located below the Directory Name field.
- Default** and **Apply** buttons are located at the bottom right of the configuration area.

FTP Enable: Click to enable FTP function.

Server IP: Enter your FTP server IP address or domain name.

Port: Enter the FTP port for file exchanges.

Name/ Password: Enter your FTP server user name and password.

Directory Name: Enter the default directory name for the FTP file exchanges.

Test FTP: Click to test the FTP settings.

5. 5 Device

In this section, you can configure the internal HDD & Cloud storage function.

5. 5.1 Disk

This menu allows you to check & configure the internal HDD(s). You need to format the HDD only at the first startup and if you replace a new HDD.

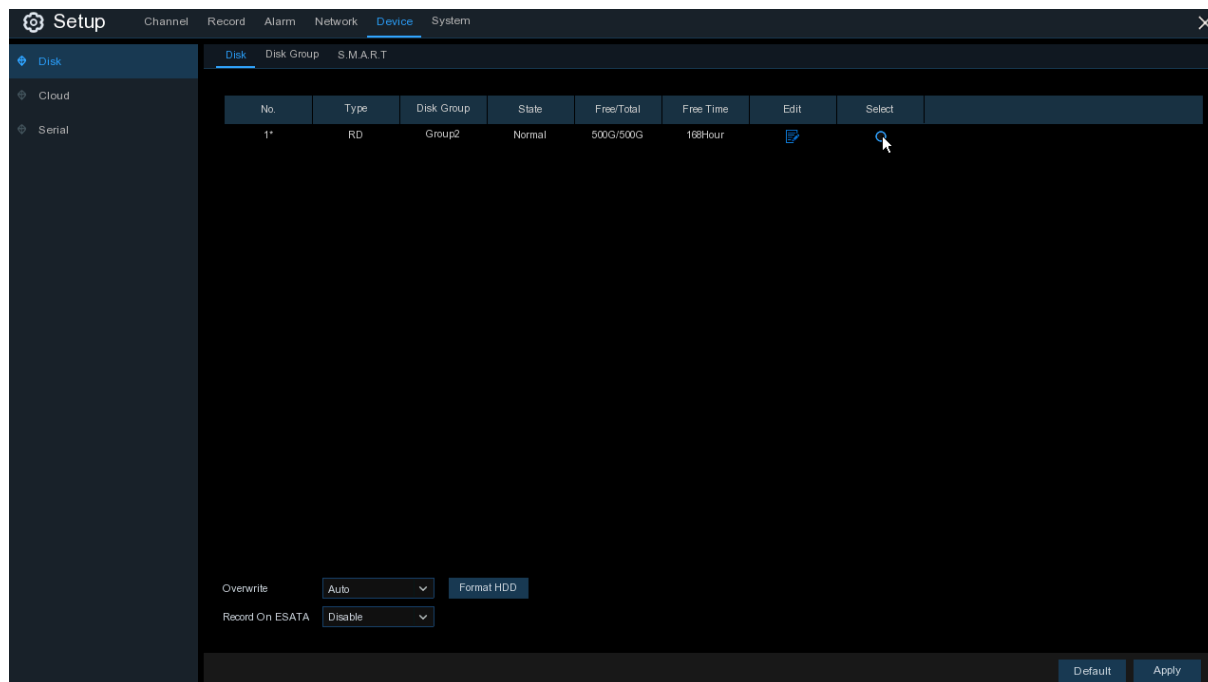

Format HDD: Select the HDD you want to format and then click **Format HDD**. To start formatting, you need to enter your user name and password and then click **OK** to confirm to continue formatting.

Overwrite: Use this option to overwrite the old recordings on the HDD when the HDD is full. For example, if you choose the option 7 days then only the last 7 days recordings are kept on the HDD. To prevent overwriting any old recordings, select **OFF**. If you have disabled this function, please check the HDD status regularly, to make sure the HDD is not full. Recording will be stopped if HDD is full.

5.5.1.1 S.M.A.R.T

This function can be used to display technical information on the hard drive installed inside your DVR. You can also perform a test (there are three types available) to evaluate and detect potential drive errors.

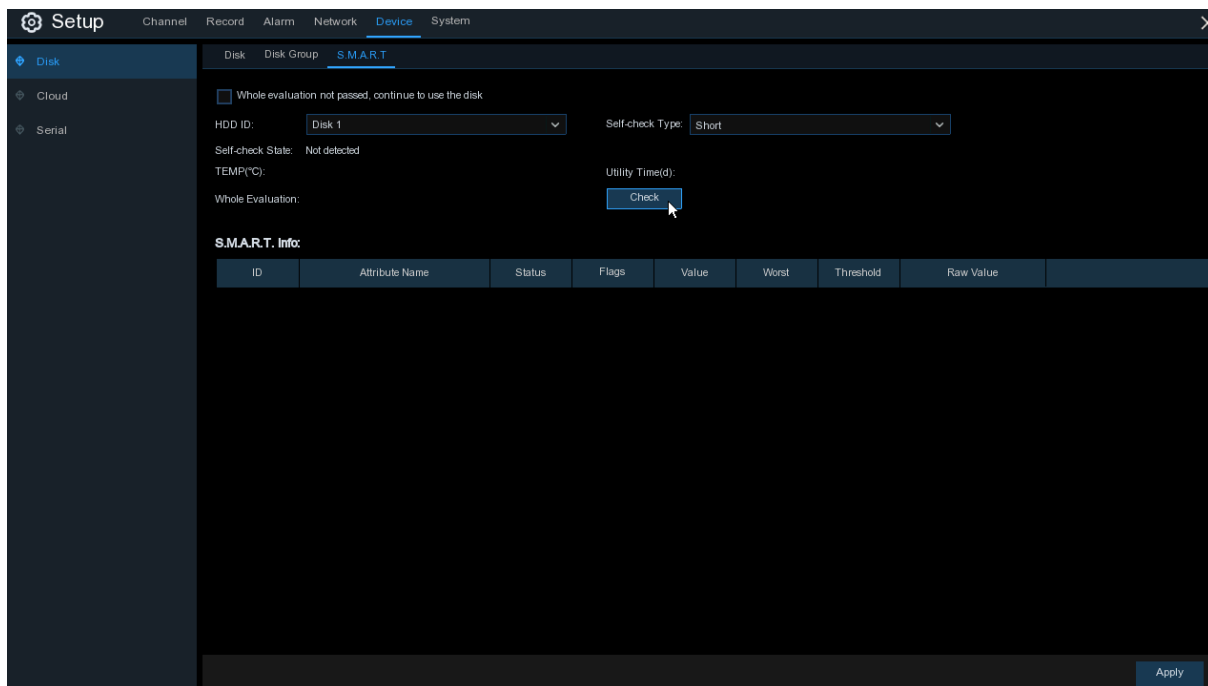

Whole Evaluation not passed, continue to use the disk: If for some reason the hard drive has developed a fault (such as one or more bad sectors), you can instruct your DVR to continue saving to the drive.

Self-check Type: There are three types available:

Short: This test verifies major components of the hard drive such as read/write heads, electronics and internal memory.

Long: This is a longer test that verifies the above as well as performing a surface scan to reveal problematic areas (if any) and forces bad sector relocation

Conveyance: This is a very quick test that verifies the mechanical parts of the hard drive are working.

Note: When performing a test, your DVR will continue to work as normal. If an HDD S.M.A.R.T error found, the HDD can be continued to use, but there will be a risk to lose recording data. It is recommended to replace a new HDD.

5.5.2 Cloud

Your DVR has the ability to upload snapshots to the cloud service via Dropbox which is a free service that allows you to easily store and share snapshots and always have them on hand when you need them.

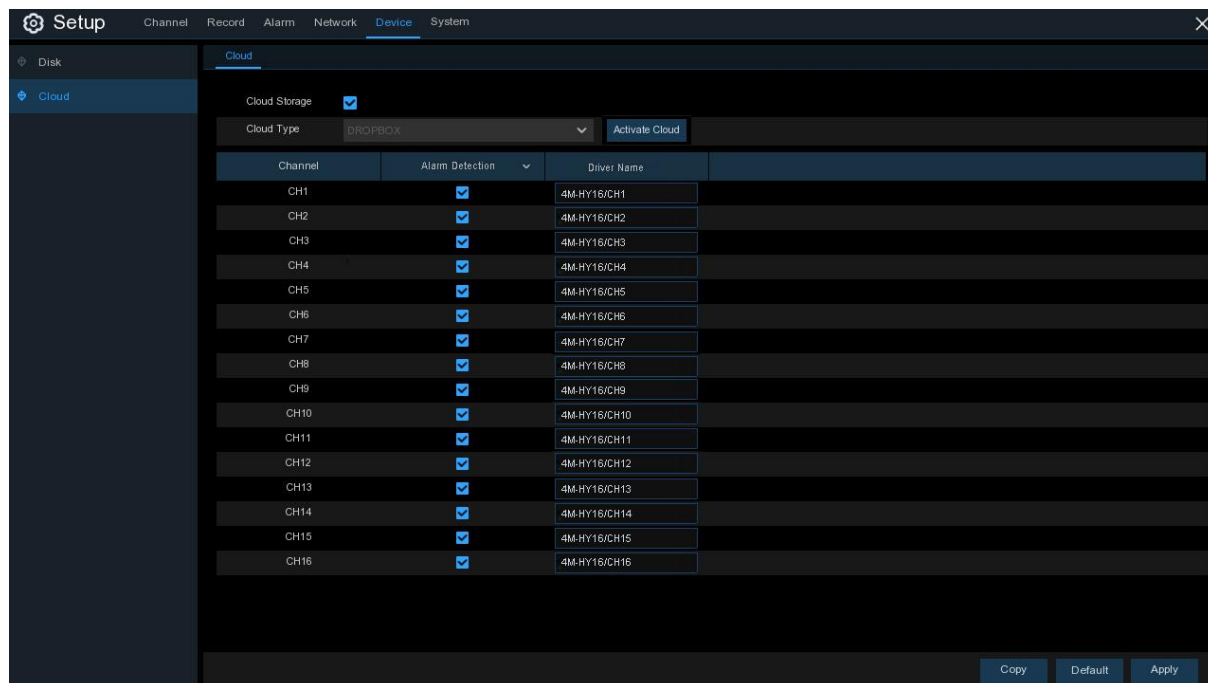

Before activating the cloud function, we recommend that you create a Dropbox account using the same email address and password used for your DVR. Go to www.dropbox.com, input your name, email address and password, agree to the terms & conditions then click the sign up button.

Cloud Storage: Check to enable the function.

Cloud Type: Only Dropbox is supported currently.

Alarm Detection: Enable if you want to upload snapshots to Dropbox when the camera detects a motion or triggered by I/O alarm.

Drive Name: Enter the cloud storage name for your DVR.

Activate Cloud: Click to activate the function. After a short moment, you will see a message on-screen. An activation link has been sent to your email (the email address which you had set to receive email alerts in [5.4.3 Email](#)). Check your email then click the link to activate. You will be taken to the Dropbox website. Click "Allow" to finalize the activation. Repeat these steps if you would like to enable cloud storage for the other cameras available.

5.6 System

Change general system information such as date, time and region, edit passwords and permissions, and more.

5.6.1 General

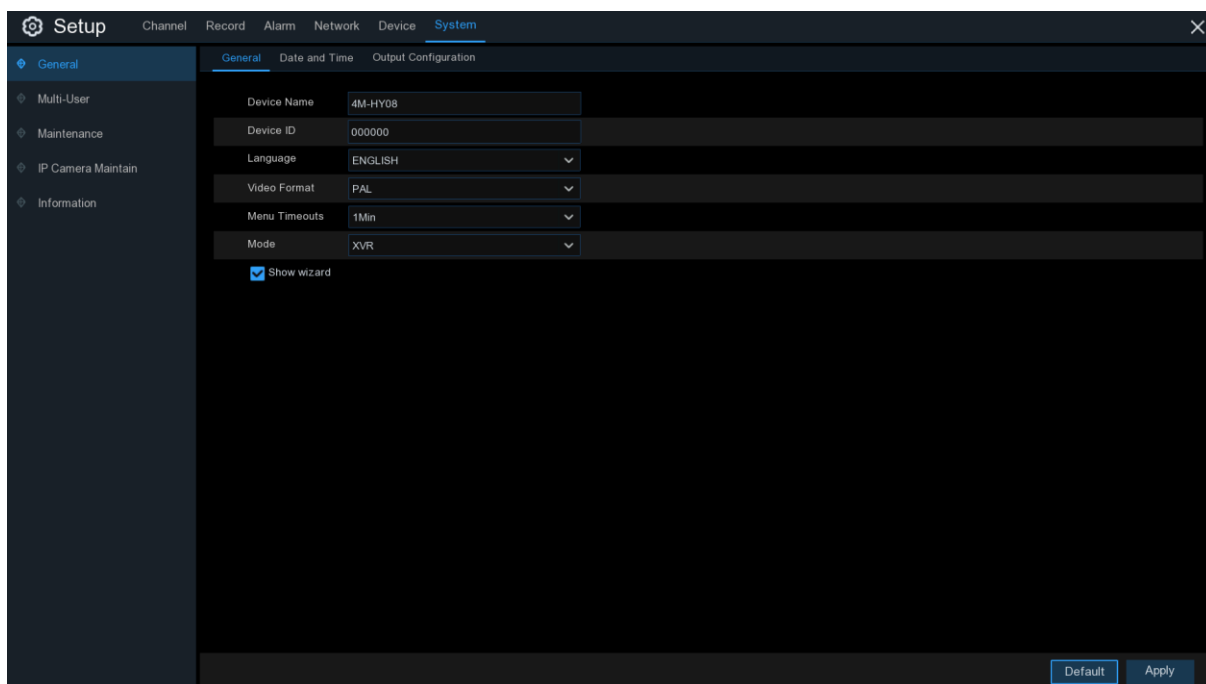

Device Name: Enter the desired name for your DVR. The name can include both letters and numbers.

Device ID: Enter the desired ID for your DVR. The device ID is used to identify the DVR, and can only be composed of numbers. For example, 2pcs DVRs are installed in the same place, the Device ID is 000000 for one of the DVRs, and 111111 for another DVR. When you want to operate the DVR with a remote controller, both of the DVR may receive the signal from controller & act at the same time. If you want to control only the DVR with ID 111111, you can input the Device ID 111111 in login page with remote controller for further operations.

Language: Select a language you would like the system menus to be displayed in. Multiple languages are available.

Video Format: Select the correct video standard for your region.

Menu Timeouts: Click the drop-down menu to select the time your DVR will exit the Main Menu when idle. You can also disable this by selecting "OFF" (password protection will be temporarily disabled).

Mode: XVR or DVR. XVR model will allow you to add IP Cameras to the DVR. If you change the mode from XVR to DVR, all added IP cameras will be deleted.

Show Wizard: Click the checkbox if you would like to display the Startup Wizard each time you turn on or reboot your DVR.

5.6.1.1 Date and Time

The screenshot shows a web-based configuration interface for a system. The top navigation bar includes 'Setup', 'Channel', 'Record', 'Alarm', 'Network', 'Device', and 'System'. The 'System' menu is active, and the 'Date and Time' sub-menu is selected. The left sidebar contains a tree view with 'General' selected, and other options like 'Multi-User', 'Maintenance', 'IP Camera Maintain', and 'Information'. The main content area is titled 'Date and Time' and contains the following settings:

- Date and Time**
 - Date: 04/14/2017 (with a calendar icon)
 - Time: 17:12:49
 - Date Format: MM/DD/YY
 - Time Format: 24Hour
 - Time Zone: GMT+08:00
- NTP Settings**
 - Enable NTP:
 - Server Address: pool.ntp.org
 - Update Now button
- DST Settings**
 - Enable DST:
 - Time Offset: 1Hour
 - Enable DST: Week
 - Start Time: Mar., The 2nd, Sun., 02:00:00
 - End Time: Nov., The 1st, Sun., 02:00:00

At the bottom right of the configuration area, there are 'Default' and 'Apply' buttons.

Date & Time

Date: Click the calendar icon to change the date.

Time: Click the dialogue box to change the time.

Date Format: Select the preferred date format.

Time Format: Select the preferred time format.

Time Zone: Select a time zone relevant to your region or city.

5.6.1.2 NTP Settings

The NTP (Network Time Protocol) function allows your DVR to automatically sync its clock with a time server. This gives it the ability to constantly have an accurate time setting (your DVR will periodically sync automatically).

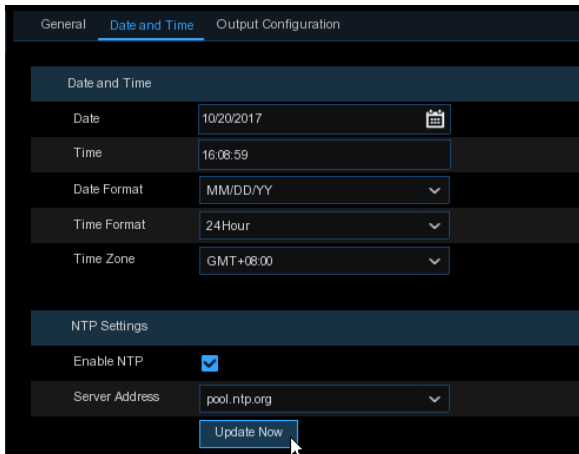

Check to enable the **NTP**, and select a **Server Address**, click Update Now to manually sync the date & time.

Click **Apply** to save your settings.

When NTP function is enabled, system will update the system time at 00:07:50 per day, or every time when the system is starting up.

5.6.1.3 DST Settings

The DST (Daylight Saving Time) function allows you to select the amount of time that Daylight Saving has increased by in your particular time zone or region.

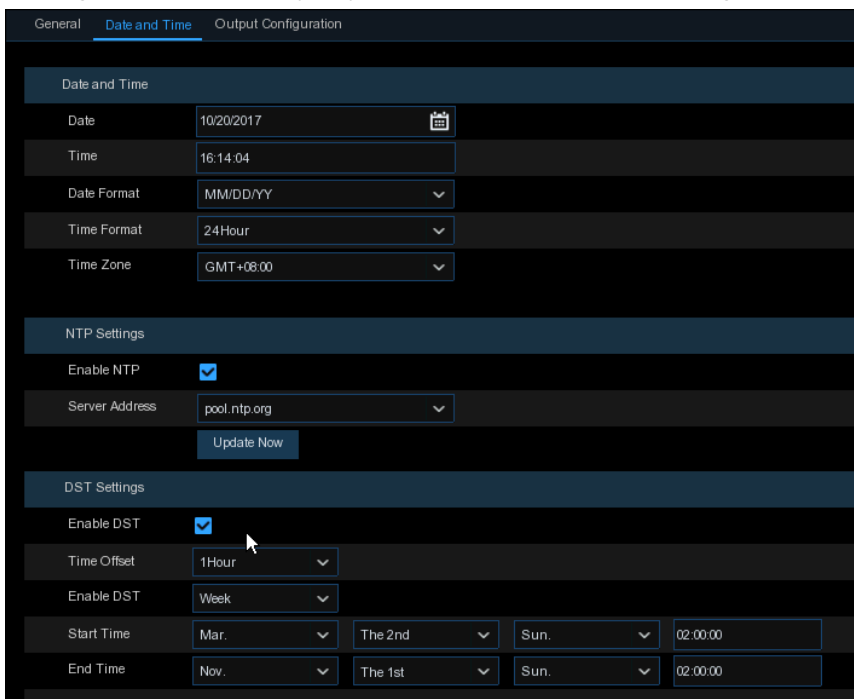

Enable DST: If Daylight Saving applies to your time zone or region, check this option to enable.

Time Offset: Select the amount of time that Daylight Saving has increased by in your time zone. This refers to the difference in minutes, between Coordinated Universal Time (UTC) and the local time.

Enable DST: You can select how Daylight Saving starts and ends:

Week: Select the month, a particular day and time when Daylight Saving starts and ends. For example, 2 a.m. on the first Sunday of a particular month.

Date: Select the start date (click the calendar icon), end date and time when Daylight Saving starts and ends.

Start Time / End Time: Set the start time and end time for Daylight Saving.

5.6.2 Output Configuration

This menu allows you to configure video output parameters.

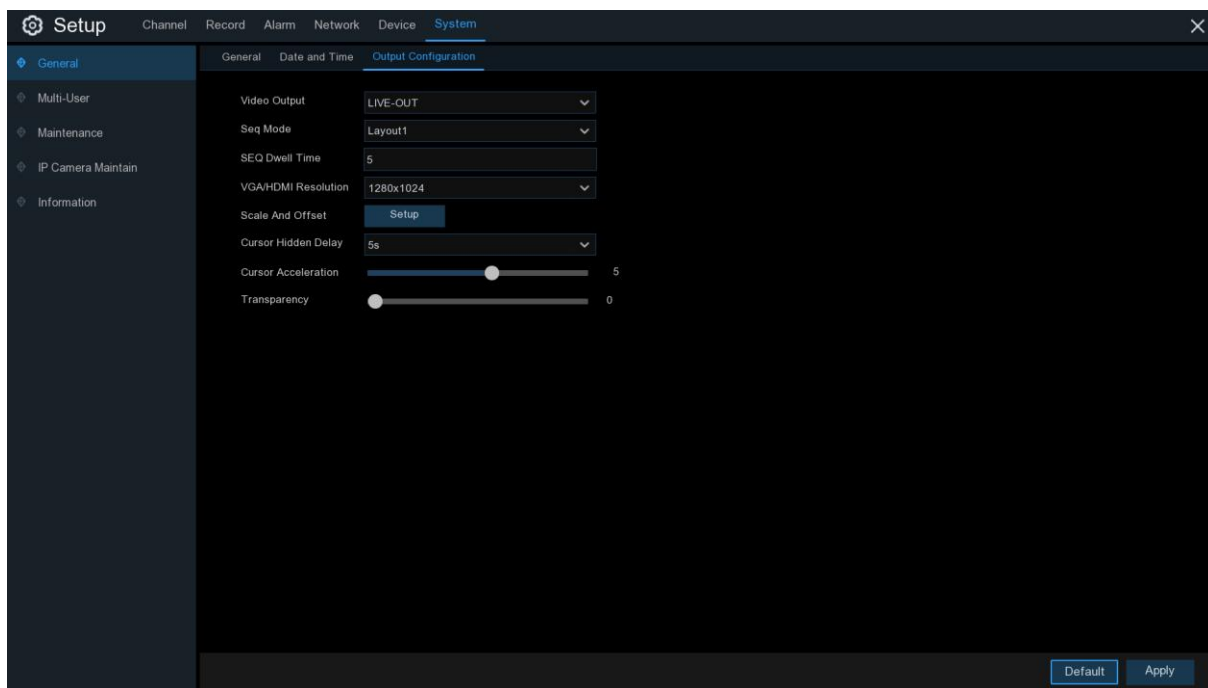

Video Output: To choose the output options:

LIVE-OUT is used to configure the main output parameters.

SPOT-OUT is an optional option to config the VGA spot output parameters.

5.6.2.1 LIVE-OUT

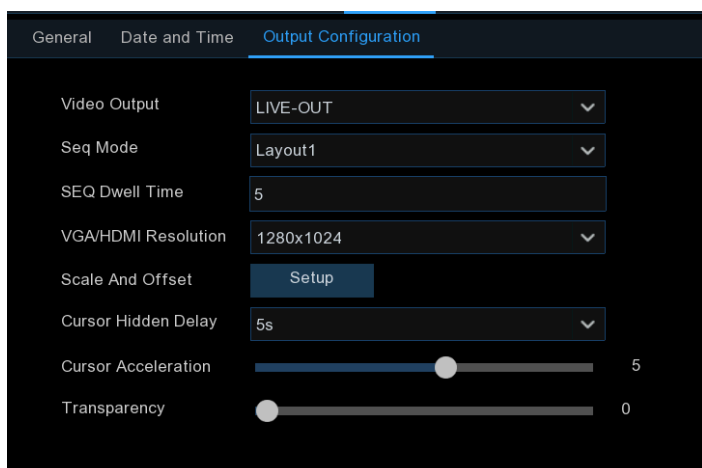

Choose **LIVE-OUT** from the Video Output drop-down menu.

SEQ Mode: Select how many video channels you would like to display when your DVR is in sequence mode.

SEQ Dwell Time: Enter in seconds the maximum length of time you would like to display a video channel in sequence mode before displaying the next video channel (300 seconds is the maximum).

Output Resolution: Select a display resolution that is suitable for your TV. 1920 x 1080 will suit most TVs. If your DVR supports 4K output resolution, you can select either 2K (2560 x 1440) or 4K (3840 x 2160) to take advantage of the higher resolution that your 4K TV provides.

Scale and Offset: The DVR supports to adjust the size & position of the display screen to match your monitor or TV. Click **Setup** button to adjust.

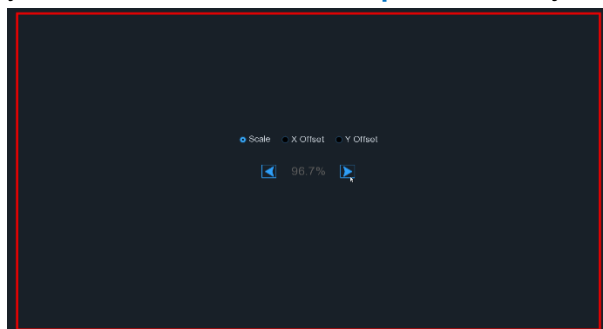

Scale: To adjust the size of the displayed screen by scale.

X Offset: To move the displayed screen to left or right.

Y Offset: To move the displayed screen to up or down.

Click once or long press the left button of your mouse on the arrow to adjust the size and position, or you can scroll the wheel of the mouse to adjust. Click the right button of your mouse to exit, and click **Apply** to save your modifications.

Cursor Hidden Delay: Click the drop-down menu to select the time your DVR will hide the mouse cursor when idle. You can also disable this by selecting “OFF” (password protection will be temporarily disabled).

Cursor Acceleration: To adjust the speed to move the mouse cursor.

Transparency: Click and hold the slider left or right to change how transparent the Menu Bar and Main Menu will appear on-screen. Adjust accordingly.

5.6.3 Multi-user

This menu allows you to configure the user name, password and user permission.

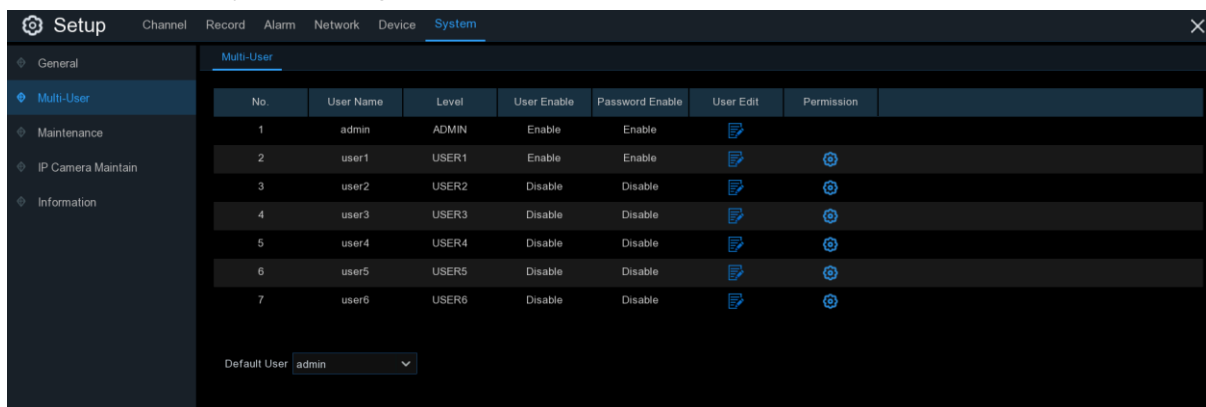

The system supports the following account types:

- **ADMIN — System Administrator:** The administrator has full control of the system, and can change both administrator and user passwords and enable/disable password protection.
- **USER — Normal User:** Users only have access to live viewing, search, playback, and other functions. You may set up multiple user accounts with varying levels of access to the system.





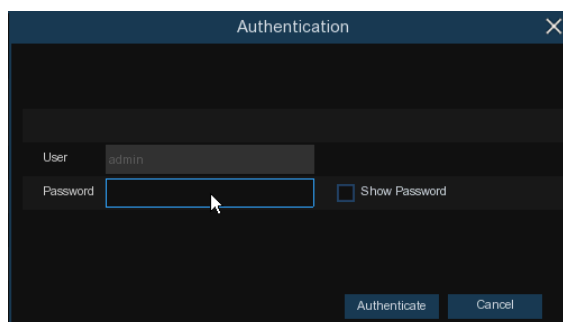
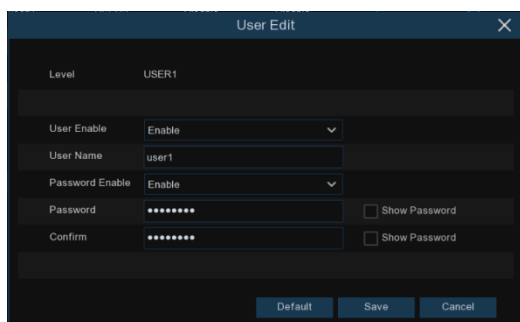







5.6.3.1 Changing Password

To change the password for the administrator or user accounts, click the User Edit icon [Edit Icon]. The password has to be a minimum of 8 characters and can contain a mixture of numbers and letters. Enter your new password again to confirm, and then click **Save** to save your new password. You will be required to input your old password to authenticate.



Password Enable: It's strongly recommended to enable the password to protect your privacy. If you want to disable the password protection, please ensure your DVR is placed in a secure place.

5.6.3.2 Add New Users

No.	User Name	Level	User Enable	Password Enable	User Edit	Permission
1	admin	ADMIN	Enable	Enable		
2	user1	USER1	Enable	Enable		
3	user2	USER2	Disable	Disable		
4	user3	USER3	Disable	Disable		
5	user4	USER4	Disable	Disable		
6	user5	USER5	Disable	Disable		
7	user6	USER6	Disable	Disable		

Default User:

1. Select one of the user accounts that is currently disabled, click the User Edit icon .

User Edit ✕

Level: USER1

User Enable: Enable

User Name:

Password Enable: Enable

Password: Show Password

Confirm: Show Password

Default
Save
Cancel

2. Select **Enable** from the drop-down next to **User Enable**.
3. Click the field next to **User Name** to change the user name for the account.
4. Select **Enable** from the drop-down next to **Password Enable**.
5. Click the field next to **Password** to enter the desired password.
6. Click the field next to **Confirm** to reenter the password.
7. Click **Save**. You will be required to input your Admin password to authenticate.

5.6.3.3 Setting User Permissions

The administrator account is the only account that has full control of all system functions. You can enable or disable access to certain menus and functions of each user account.

No.	User Name	Level	User Enable	Password Enable	User Edit	Permission
1	admin	ADMIN	Enable	Enable		
2	user1	USER1	Enable	Enable		
3	user2	USER2	Disable	Disable		
4	user3	USER3	Disable	Disable		
5	user4	USER4	Disable	Disable		
6	user5	USER5	Disable	Disable		
7	user6	USER6	Disable	Disable		

Default User:

1. Click the edit icon under Permission tab.

User Permission ✕

User Name:

Log Search
 Disk
 Backup

Parameter
 Remote Login

Maintain
 SEQ Control

Manual Record
 Manual Capture

Live
 Analog Channels 1 2 3 4 5 6 7 8
 IP Camera 1 2 3 4 5 6 7 8 9 10 11 12

Playback
 Analog Channels 1 2 3 4 5 6 7 8
 IP Camera 1 2 3 4 5 6 7 8 9 10 11 12

PTZ
 Analog Channels 1 2 3 4 5 6 7 8
 IP Camera 1 2 3 4 5 6 7 8 9 10 11 12

2. Check the boxes next to any system menus or capabilities you would like the user to access. Click **All** to check all boxes. Click **Clear** to check none of the boxes.
3. Click **Save** to save your modifications.

5.6.4 Maintenance

In this section, you will be able to search & view the system log, load default settings, upgrade the system, export & import system parameters and manager system auto reboot.

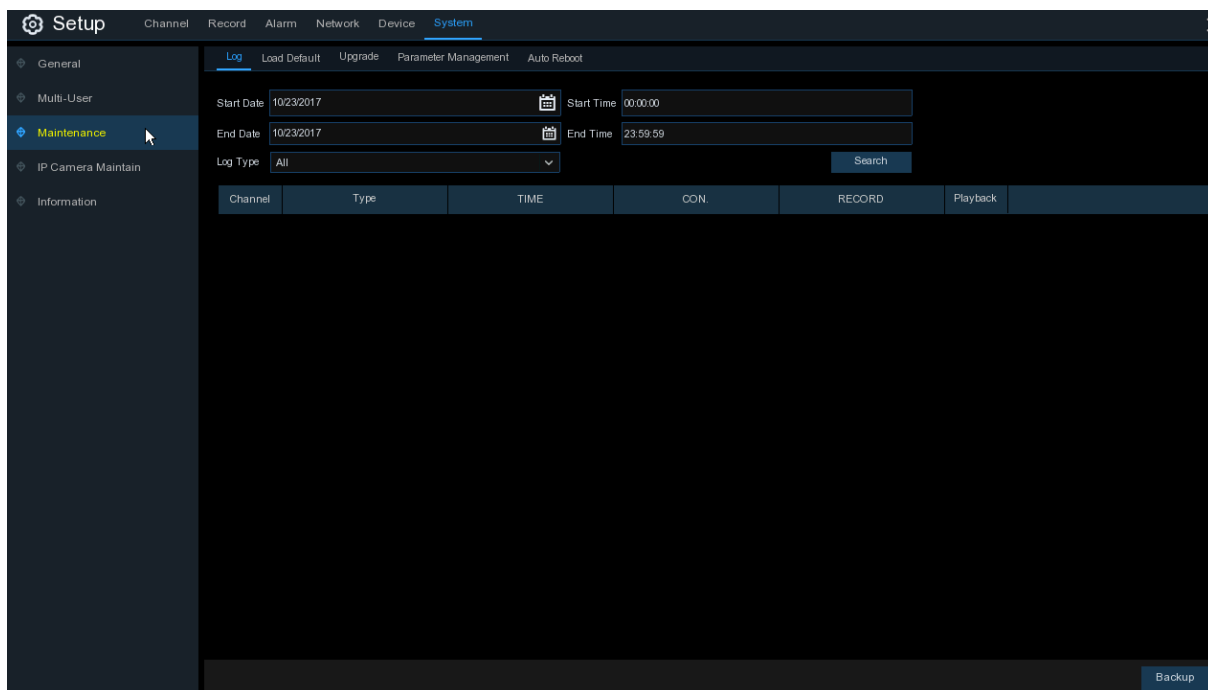

5.6.4.1 Log

The system log shows you important system events, such as motion alarms and system warnings. You can easily create a backup file of the system log for a set time period to a USB flash drive.

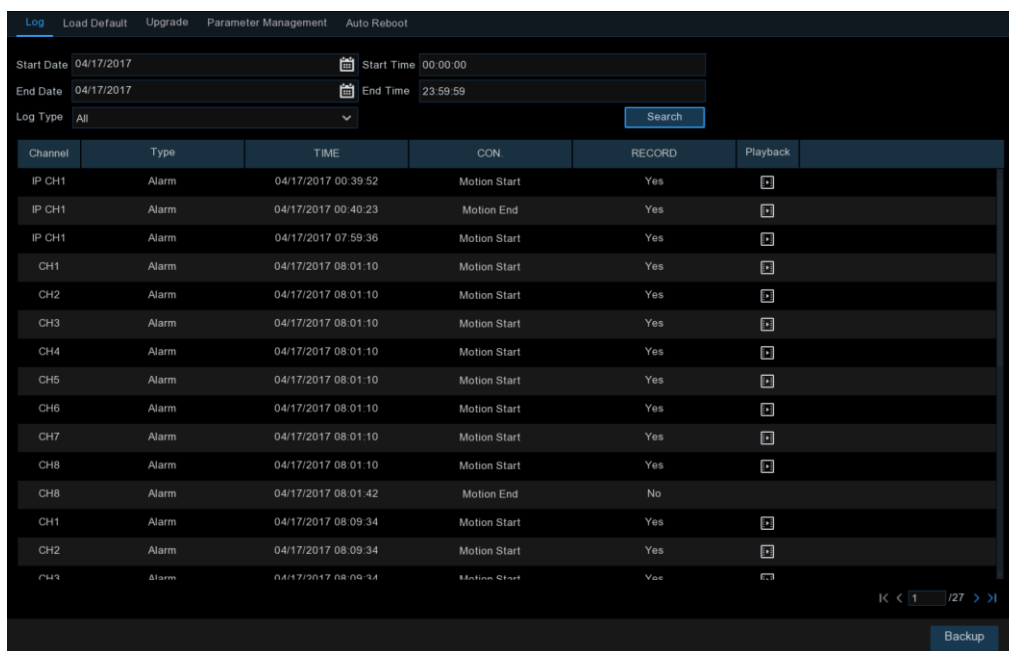

Log Searching and Backing Up:

1. Click the field next to **Start Date & Start Time** to choose the starting date & time for your search from the on-screen calendar.
2. Click the field next to **End Date & End Time** to choose the end date & time for your search from the on-screen calendar.
3. Select the type of events you would like to search for from the dropdown next to **Log Type**, or select **All** to see the entire system log for the selected time period.
4. Click **Search**.
5. Browse system log events from your search period:
 - Video events can be played back instantly by clicking in the **Playback** column. Right-click to return to your search results.
 - Use the **<< / >>** buttons in the bottom-right corner of the menu to move between pages of system log events.
6. Click **Backup** to create a backup of the system log for your search period. Please make sure your flash derive has been connected to the DVR's USB port.
7. The backup drive menu appears. Navigate to the folder you want the backup file to be saved in, then click **OK** to begin.

5.6.4.2 Load Default

Reset the DVR settings to its out-of-box state. You can choose to reset all settings at once, or just settings on specific menus. Restoring default settings will not delete recordings and snapshots saved to the hard drive.

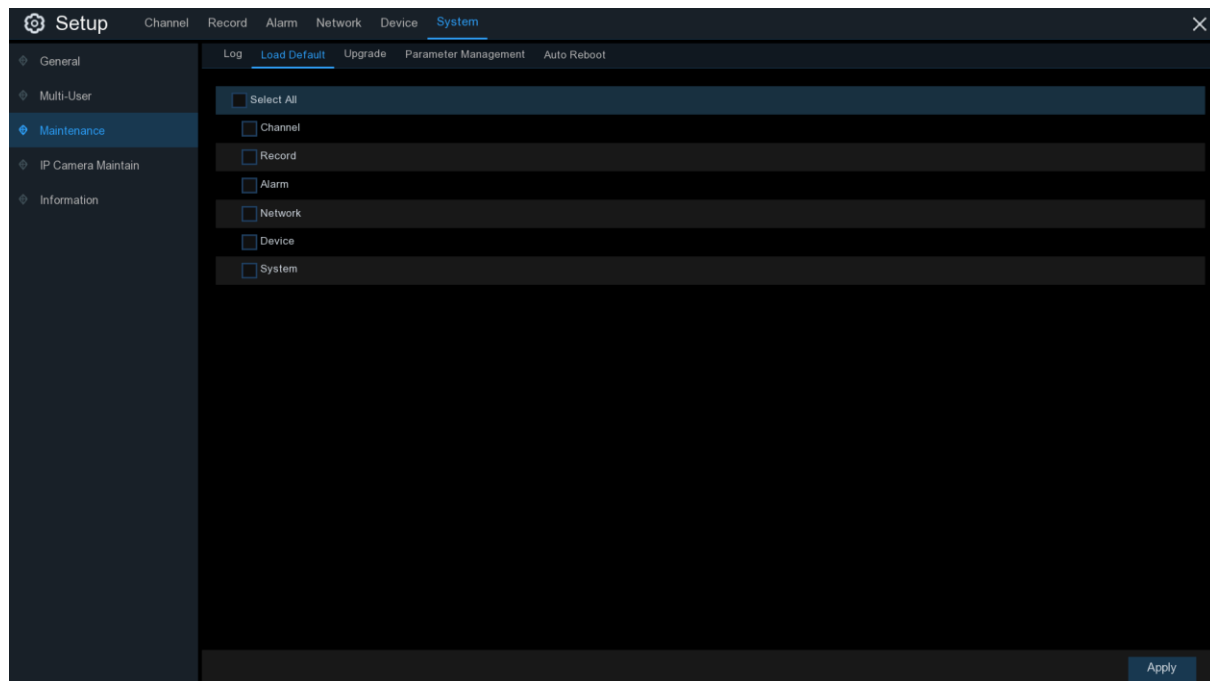

Check the items you want restore, or check **Select All** to choose all items. Click **Apply** to load default settings of your chosen items.

5.6.4.3 Upgrade

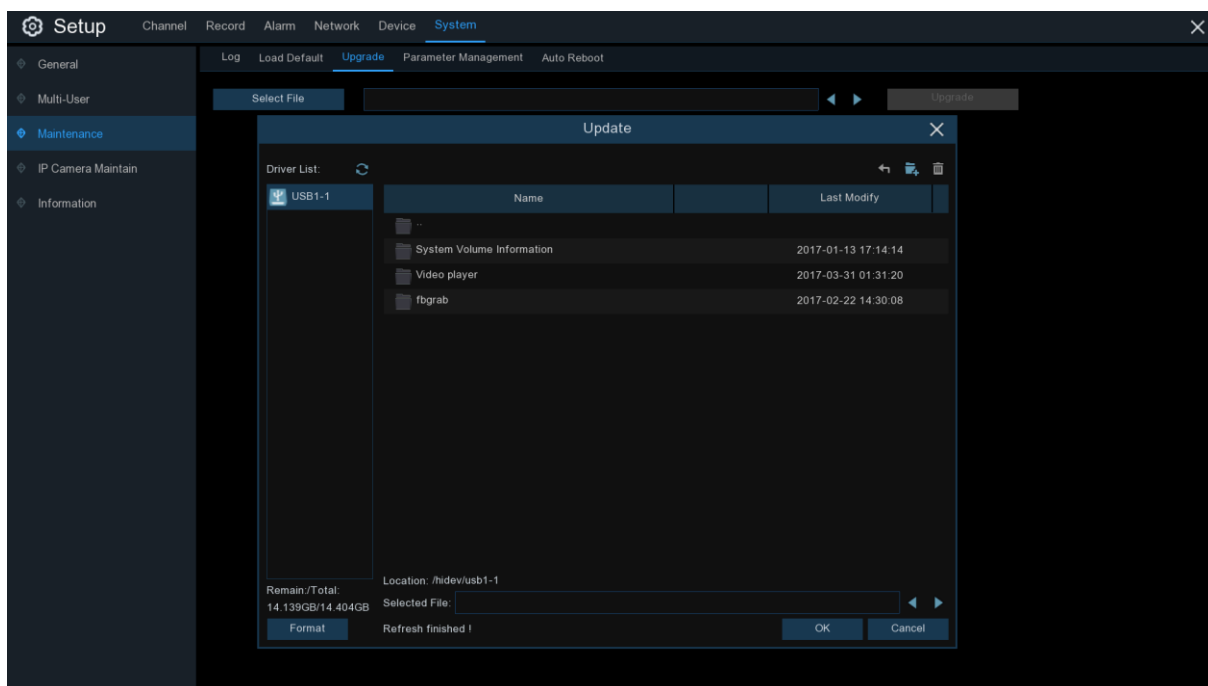

1. Copy the firmware file (.sw file) to your USB drive, and insert the USB flash drive into the DVR's USB port.
2. Click Select File button to choose the firmware file in your USB flash drive, then Click **OK**.
3. Click **Upgrade** button to start system upgrade. The system upgrade will last around 5-10 minutes, please do **NOT** power off the DVR or remove the USB from DVR during firmware upgrade.

5.6.4.4 Parameter Management

You can export the main menu settings you have configured to a USB flash drive, or import an exported setting file from USB flash drive to the DVR.

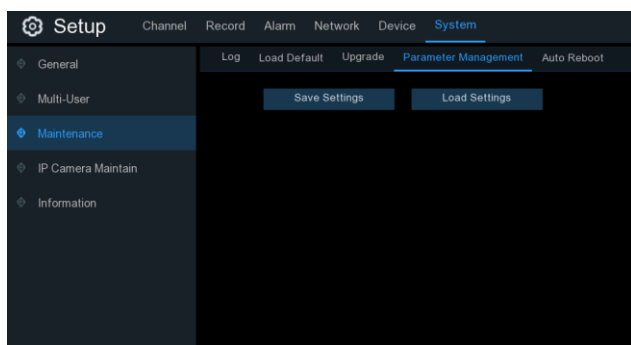

Save Settings: Click to save the DVR current system settings to the USB device. You will be required to input the Admin password to authenticate.

Load Settings: Once you have created a system settings export, you can import the settings on another DVR. Click **Load Settings** button to navigate to the system settings file you want to import from your USB flash driver. You will be required to input the Admin password to authenticate.

5.6.4.4 Auto Reboot

This menu allows the system to auto reboot the DVR regularly. It is recommended to leave this function enabled, as it maintains the operational integrity of your DVR.

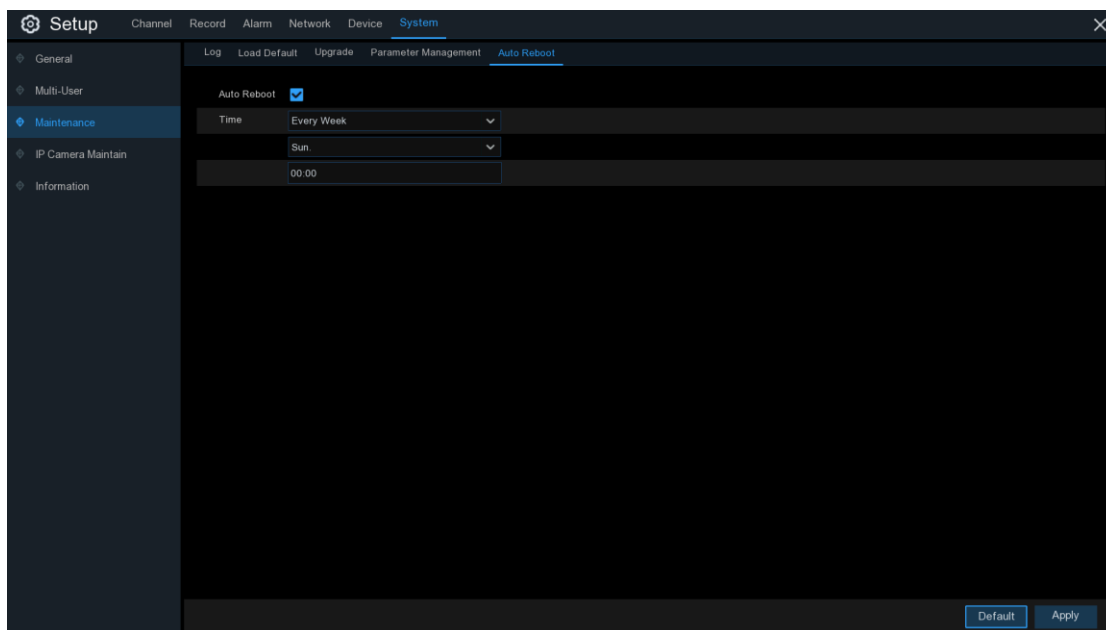

Auto Reboot: Check to enable.

Time: You can set the DVR to reboot by day, week or month.

5.6.5 IP Camera Maintain

This menu allows you to upgrade the IP camera's firmware and restore default settings of IP camera.

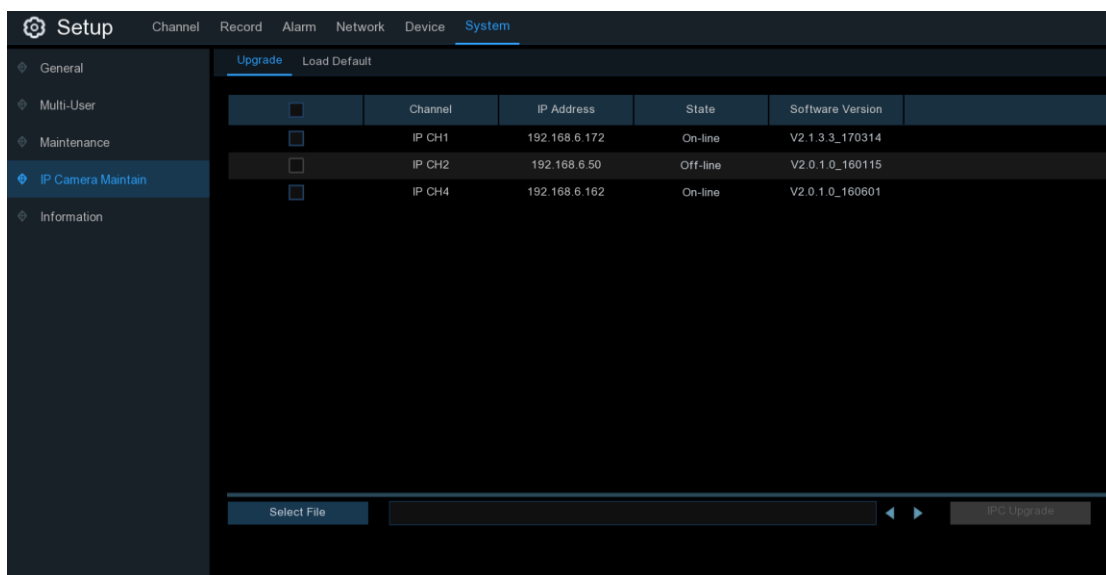

5.6.5.1 Upgrade IP Camera

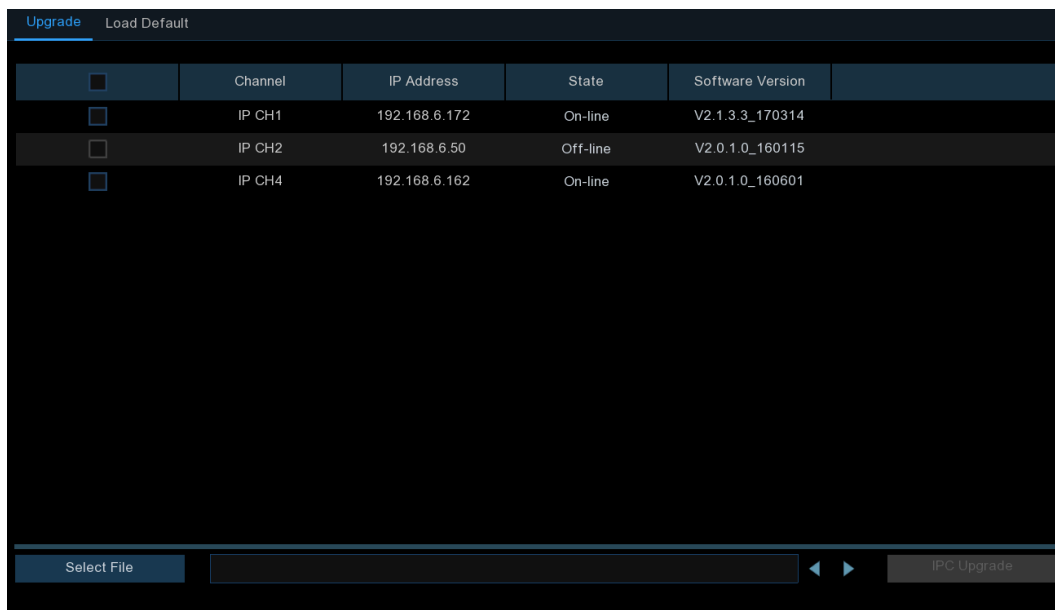

1. Choose one of the IP cameras you want to upgrade firmware.
2. Click **Select File** select the update file from your USB flash drive, then click **OK**.
3. Click IPC Upgrade button to start upgrading. You will be required to input the Admin password to authenticate. Please do **NOT** power off the DVR and IP camera or remove the USB during the upgrading.

5.6.5.2 Load Default Settings for IP Camera

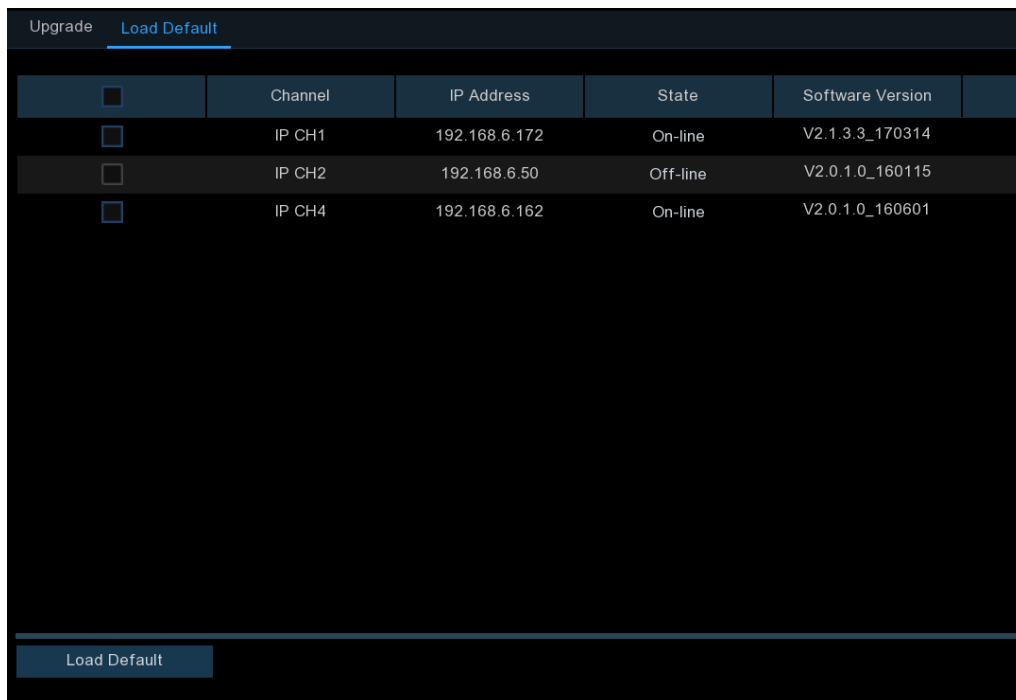

1. Choose the IP cameras you want to restore.
2. Click **Load Default** to restore settings. You will be required to input the Admin password to authenticate.

5.6.6 System Information

This menu allows you to view the system information, channel information, record information & network status.

5.6.6.1 Information

View system information such as device ID, device model name, IP address, MAC address, firmware version and more.

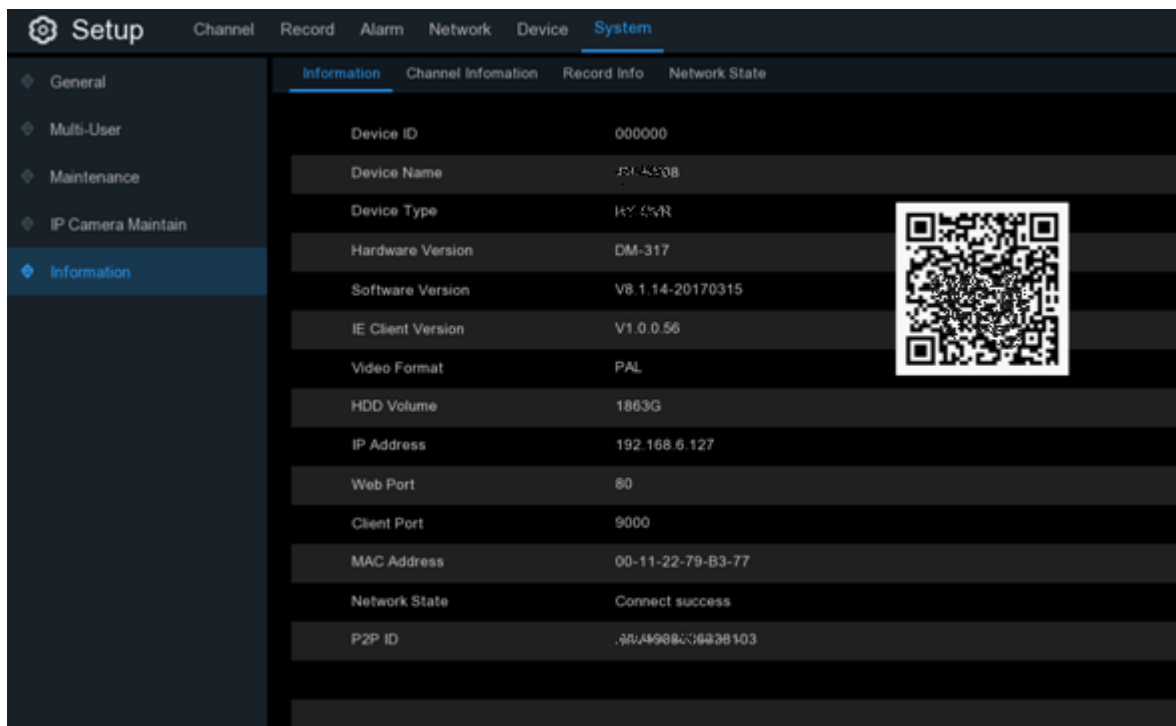

If your DVR supports P2P function, you will find the P2P ID & P2P QR code in the information page. You can scan this QR cord with mobile app to remote view the DVR.

5.6.6.2 Channel Information

Channel	Alias	State	Mainstream	Substream	Motion Detection	Privacy Zone
CH17	CH17	On-line	704x 480, 30Fps, 32Kbps	704x 480, 0Fps, 8Kbps	Support	Support
CH18	CH18	On-line	704x 480, 30Fps, 32Kbps	704x 480, 0Fps, 8Kbps	Support	Support
CH19	CH19	On-line	704x 480, 30Fps, 32Kbps	704x 480, 0Fps, 8Kbps	Support	Support
CH20	CH20	On-line	704x 480, 30Fps, 32Kbps	704x 480, 0Fps, 8Kbps	Support	Support
CH21	CH21	On-line	704x 480, 30Fps, 32Kbps	704x 480, 0Fps, 8Kbps	Support	Support
CH22	CH22	On-line	704x 480, 30Fps, 32Kbps	704x 480, 0Fps, 8Kbps	Support	Support

View channel information for each connected camera such as alias, mainstream and substream recording specifications, motion detection status & privacy zone.

5.6.6.3 Record Information

Channel	Record State	Record Switch	Stream Type	Resolution	FPS	Bitrate
CH17	OFF	Enable				
CH18	OFF	Enable				
CH19	OFF	Enable				

View recording information for each connected camera such as bitrate, stream type, recording resolution and frame rate (FPS).

5.6.6.4 Network State

Attribute	Value
WLAN	
IP Address	192.168.1.100
Subnet Mask	255.255.255.0
Gateway	192.168.1.1
MAC Address	38-72-29-03-A3-23
DHCP	Enable
Internal Interface	
IP Address	10.10.25.100
Subnet Mask	255.255.0.0
DNS1	192.168.1.1
DNS2	8.8.8.8
PPPoE	Disable
Port	
Web Port	80
Client Port	9000
RTSP Port	554
UPNP	Disable
Total Band Width:	320Mbps
Used Band Width:	5.013Mbps

View network information.

Total Band Width: It shows the DVR's total input band width for IP cameras.

Used Band Width: It shows the used band width of IP cameras.

Chapter 6 Search, Playback & Backup

The Search function gives you the ability to search for and play previously recorded videos as well as snapshots that are stored on your DVR's hard drive. You have the choice of playing video that matches your recording schedule, manual recordings or motion events only. The Backup function gives you the ability to save important events (both video and snapshots) to a USB flash drive.

6.1 Using Search Function

Click  **Search** button in the Start Menu to enter search section.

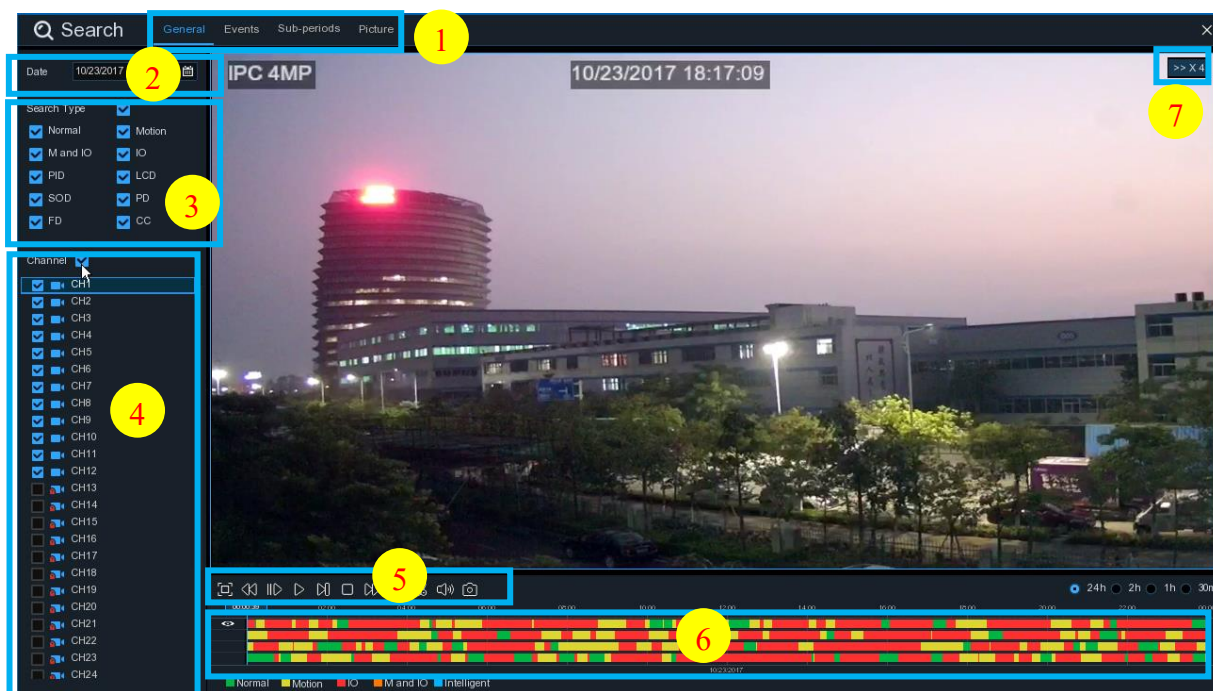













1. **Search Options:** the system provides various search & playback methods: General, Events, Sub-periods, Smart & Pictures
2. **Search Date:** search by a date to play back.
3. **Search Type:** the system provides different search types to narrow your search.
4. **Channel Selection:** to choose the channels you want to search & play.
5. **Video Playback Controls:** to control the video playback.



 Enlarge the video playback to full screen

 Rewind, x2, x4, x8 and x16

 Slow Play, 1/2, 1/4 and 1/8, 1/16 speed

-  Play
-  Pause
-  Play frame by frame. Click once to play a frame of the video
-  Stop
-  Fast Forward, x2, x4, x8 and x16
-  Digital Zoom: Click to zoom in then click-and-drag on a camera image during playback to zoom in on the selected area. Right-click to return to regular playback.
-  Video Clip. Quickly save a section of video to a USB flash drive. View more on [6.1.1.1 Video Clip Backup](#)
-  Save Video Clip.
-  Volume Control: scroll the slider bar to increase or decrease volume.
-  Snapshots: to capture a snapshot image to your USB flash drive. If the video playback is in split-screen view, move the mouse cursor to the channel you want to capture, and then click the  icon to save the snapshot.

6. Timeline: Continuous recordings are shown with colored bars to represent different types of recording (legend shown in the bottom-right corner of the display). Use the timeframe options

() to view a smaller or larger time period.

Different types of recording shown in different colors:



Continuous Recording in **Green** color;

Motion Recording in **Yellow** color;

I/O Recording in **Red** color;

Motion & I/O Recording in **Orange** color;

Intelligent Recording in **Blue** color;





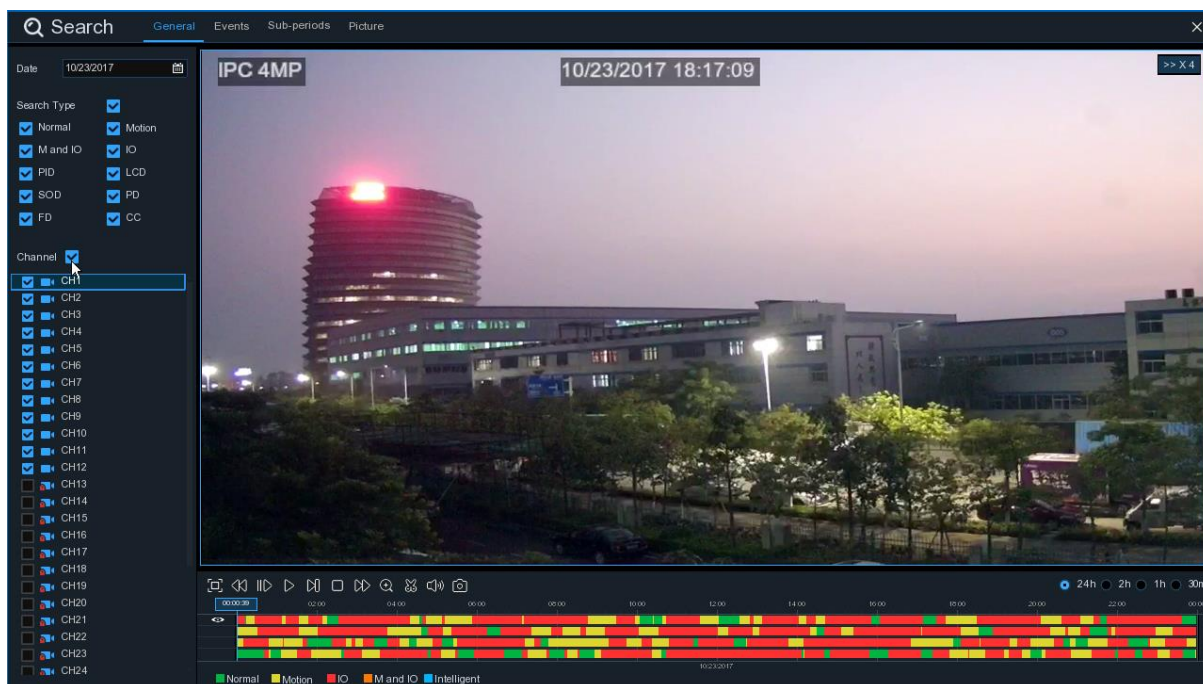

PIR Recording in **Purple** color;

7. Playback Status: display the video play status.

6.1.1 Search & Play Video in General

This menu gives an option to search & play recording for a selected date.



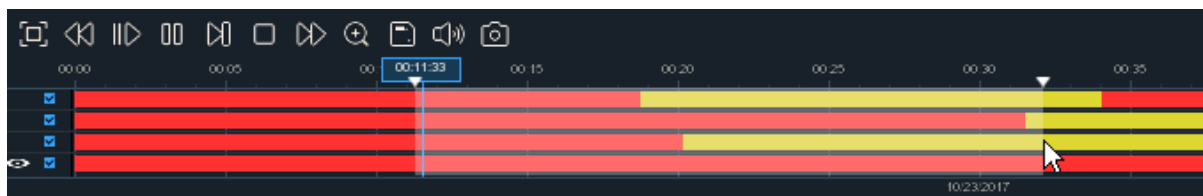

1. Select a date to search for video recording from the calendar.
2. Choose a search type.
3. Check channels you would like to search, or check **Channel** to search all connected channels.
4. The search result will display on the timeline from 00:00 to 24:00.
5. Click  button to start playback.
6. Control the playback with buttons on **Video Playback Controls**.
7. Use the timeframe options (   ) to view a smaller or larger time period.
8. If you want to quickly save a section of video during playing back to a USB flash drive, use the  **Video Clip** backup function.

6.1.1.1 Video Clip Backup



1. Insert your USB flash drive to the DVR.
2. Start a video recording playback.
3. Click  icon.
4. Check the channel(s) you want to make a video clip backup.
5. Move the mouse cursor to the timeline where you want to start the video clip.

6. Press and hold the left button of your mouse, and drag the drag the cursor to the timeline where you want to end the video clip.
7. The  icon has been changed to  icon, click  to save the video clip.
8. Select a file type for your backup files, click **Save** button to save the video clips. Please make sure your USB driver has enough space to save the video clips.

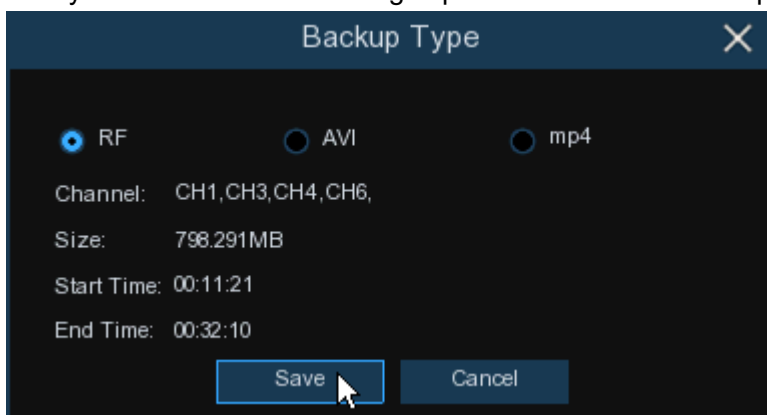

9. The backup drive menu appears. Navigate to the folder you want the backup files to save in.
10. Click **OK** to begin. The progress bar at the bottom of the window shows you the progress of the backup.

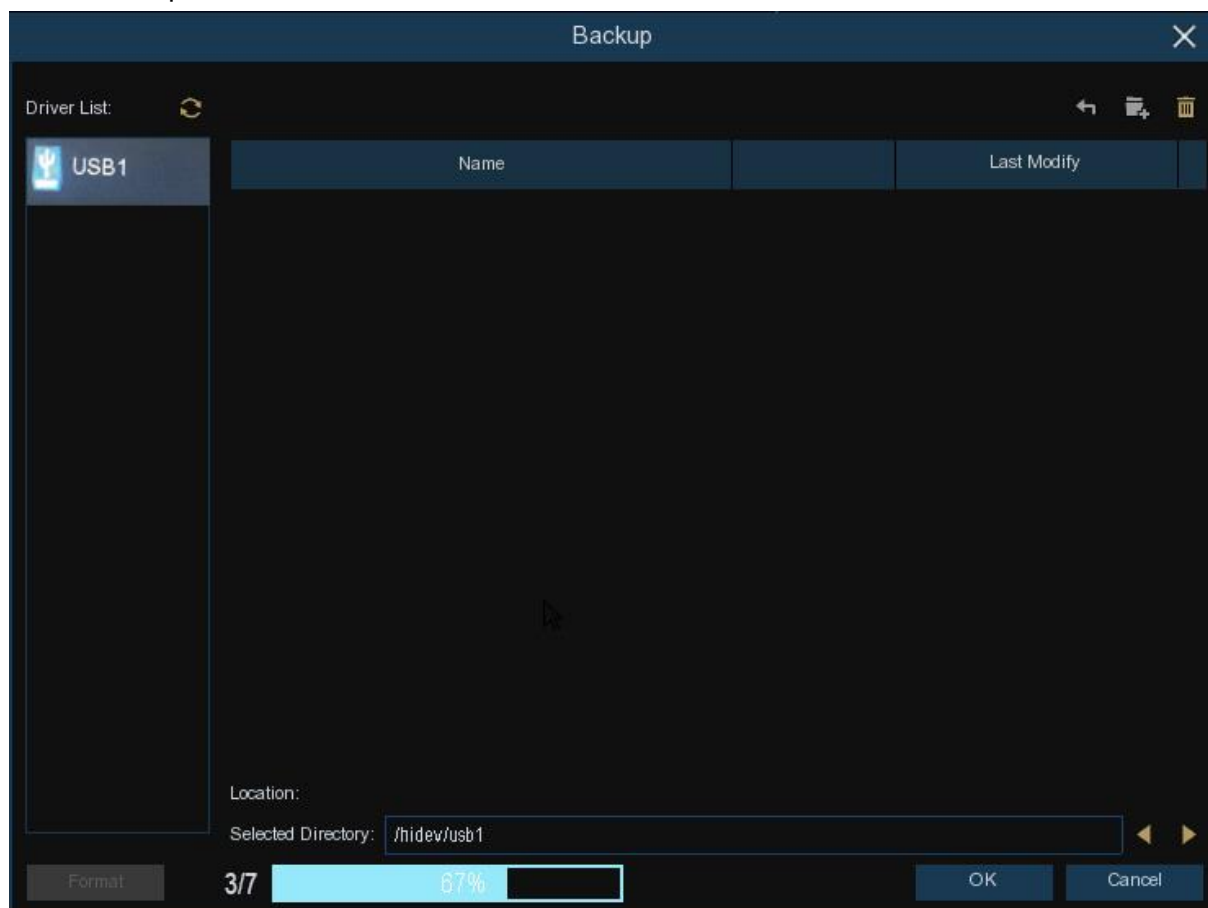

6.1.2 Event Search, Playback & Backup

Event search lets you view a list of video recordings with the channel, start and end time, and recording type conveniently summarized. You can also quickly back up events to a USB flash drive.

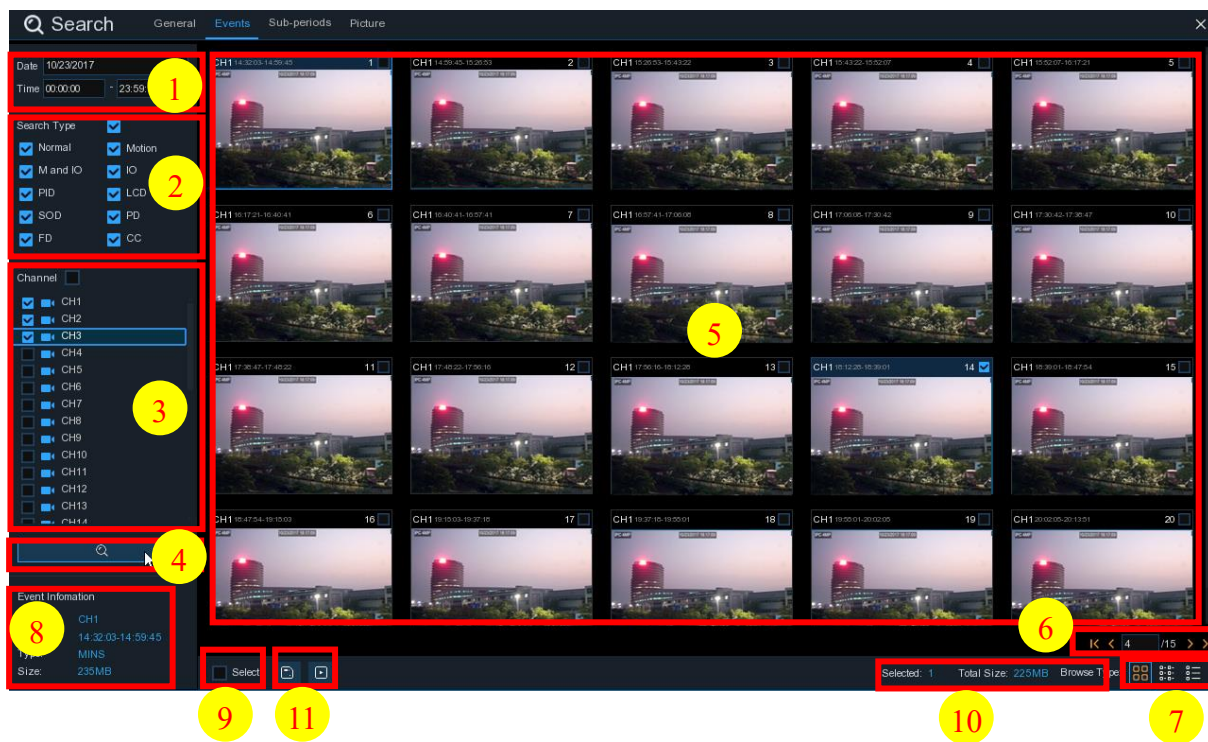

To search, play & back up for events:

1. Choose the date & time you want to search.
2. Check the recording types you want to search, or check **Search Type** to choose all.
3. Choose the channels you want to search, or check **Channel** to choose all channels.
4. Click icon to start search.
5. Events fitting your search criteria are displayed in list form. You can double click the left button of your mouse upon one of the events to play the video immediately.
6. Click icons in the bottom-right corner of the menu to browse between pages of events, or input the page you want to browse.
7. You can switch the view of list form in by clicking below icons which is show at the right bottom corner of the screen:



Thumbnails view. You can view the snapshots of the events.



List view. The events will be displayed in list.

1	CH1	00:00:00	2	CH1	00:00:45	3	CH1	00:18:30	4	CH1	00:44:03	5	CH1	01:10:48	6	CH1	01:19:22	7	CH1	01:35:37	8	CH1	01:43:32
9	CH1	02:01:12	10	CH1	02:25:38	11	CH1	02:43:17	12	CH1	03:02:08	13	CH1	03:08:37	14	CH1	03:10:01	15	CH1	03:14:54	16	CH1	03:42:12
17	CH1	04:07:23	18	CH1	04:19:35	19	CH1	04:36:40	20	CH1	05:00:20	21	CH1	05:24:12	22	CH1	05:45:55	23	CH1	06:04:07	24	CH1	06:14:27
25	CH1	06:41:12	26	CH1	06:44:25	27	CH1	07:01:42	28	CH1	07:20:43	29	CH1	07:31:23	30	CH1	07:48:04	31	CH1	08:17:33	32	CH1	08:40:16
33	CH1	08:50:34	34	CH1	09:07:05	35	CH1	09:25:12	36	CH1	09:44:07	37	CH1	09:46:08	38	CH1	10:00:52	39	CH1	10:14:18	40	CH1	10:34:42
41	CH1	10:45:57	42	CH1	11:12:48	43	CH1	11:20:27	44	CH1	11:48:18	45	CH1	12:07:25	46	CH1	12:30:12	47	CH1	12:44:43	48	CH1	12:55:49
49	CH1	13:06:48	50	CH1	13:30:45	51	CH1	13:37:51	52	CH1	13:57:01	53	CH1	14:10:24	54	CH1	14:11:16	55	CH1	14:18:12	56	CH1	14:35:26
57	CH1	14:40:31	58	CH1	14:44:42	59	CH1	14:48:38	60	CH1	15:15:44	61	CH1	15:39:06	62	CH1	16:01:07	63	CH1	16:16:00	64	CH1	16:24:41
65	CH1	16:27:29	66	CH1	16:43:47	67	CH1	16:45:43	68	CH1	17:01:14	69	CH1	17:05:03	70	CH1	17:28:30	71	CH1	17:54:23	72	CH1	18:08:49
73	CH1	18:36:07	74	CH1	18:44:14	75	CH1	18:57:14	76	CH1	19:07:37	77	CH1	19:12:12	78	CH1	19:36:50	79	CH1	19:50:34	80	CH1	20:01:42
81	CH1	20:25:40	82	CH1	20:34:32	83	CH1	20:49:48	84	CH1	21:04:51	85	CH1	21:21:09	86	CH1	21:42:12	87	CH1	21:47:36	88	CH1	22:02:49
89	CH1	22:29:59	90	CH1	22:39:14	91	CH1	22:54:42	92	CH1	22:57:45	93	CH1	23:08:03	94	CH1	23:22:59	95	CH1	23:35:50			

 **Detailed view.** You can view the details of the events.



	Channel	Type	Date	Start Time	End Time	Size	Playback	Lock	
<input type="checkbox"/>	1	CH1	MINS	10/23/2017	00:00:00	00:00:45	6MB		
<input type="checkbox"/>	2	CH1	MINS	10/23/2017	00:00:45	00:18:30	150MB		
<input type="checkbox"/>	3	CH1	MINS	10/23/2017	00:18:30	00:44:03	217MB		
<input type="checkbox"/>	4	CH1	MINS	10/23/2017	00:44:03	01:10:48	227MB		
<input type="checkbox"/>	5	CH1	MINS	10/23/2017	01:10:48	01:19:22	72MB		
<input type="checkbox"/>	6	CH1	MINS	10/23/2017	01:19:22	01:35:37	138MB		
<input type="checkbox"/>	7	CH1	MINS	10/23/2017	01:35:37	01:43:32	67MB		
<input type="checkbox"/>	8	CH1	MINS	10/23/2017	01:43:32	02:01:12	150MB		
<input type="checkbox"/>	9	CH1	MINS	10/23/2017	02:01:12	02:25:38	207MB		
<input type="checkbox"/>	10	CH1	MINS	10/23/2017	02:25:38	02:43:17	150MB		
<input type="checkbox"/>	11	CH1	MINS	10/23/2017	02:43:17	03:02:08	160MB		
<input type="checkbox"/>	12	CH1	MINS	10/23/2017	03:02:08	03:08:37	55MB		

In the detailed view mode, you can lock the video events to keep events from being overwritten in the hard drive. Click the  icon to lock or click  to unlock the events.

- When you click the left button of your mouse upon one of the event, system will show the event information on the left bottom corner of the screen.
- Check the box next the number of the event to select files, or check the box next **Select** to select all events in the page.
- The number of selected files, total size information will be displayed at the right bottom of the screen.
- After selecting file, you can click  icon to save the video to USB flash drive. Or click  icon into event playback control window to play the video.

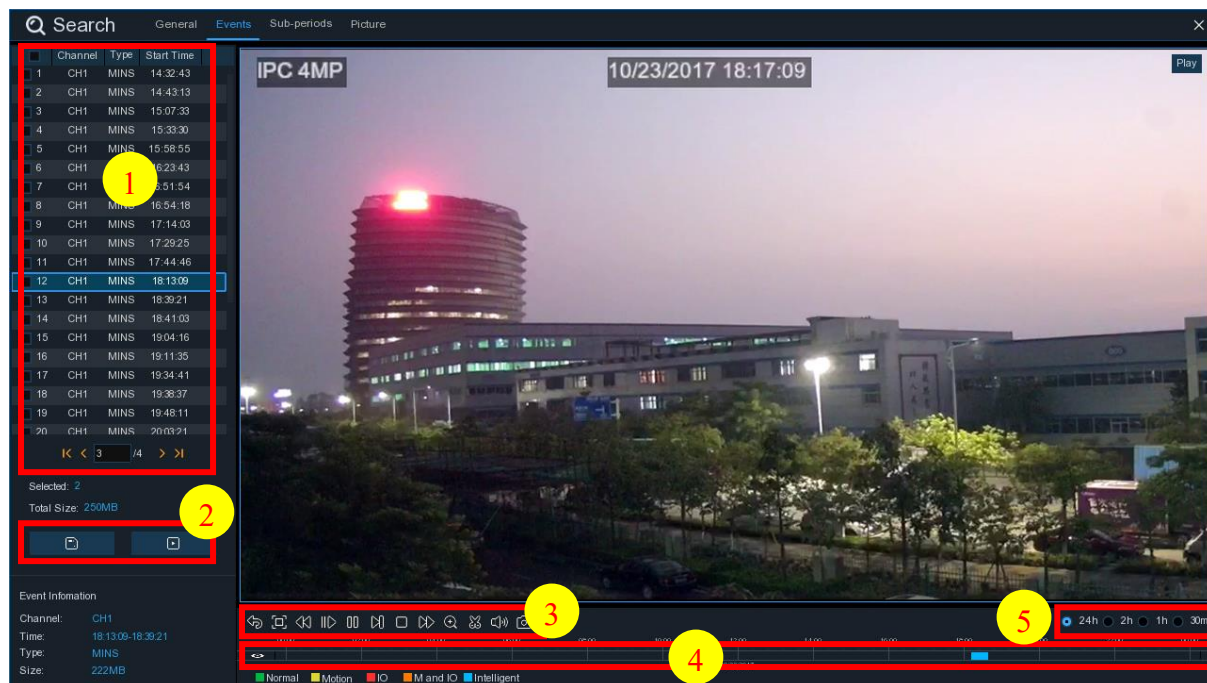
6.1.2.1 Event Playback Control



- Event List, you can select the events here.
- Click  icon to save your selected event videos to USB flash drive. Click  icon to play video.
- Control the playback with buttons on **Video Playback Controls**. You can click  icon or click right button of your mouse to exit the playback and return to event search window.

- The event you are playing now will be displayed on the timeline.
- Use the timeframe options (24h 2h 1h 30m) to view a smaller or larger time period.

6.1.3 Sub-periods Playback

Sub-periods playback allows you to play multiple normal recordings and motion events simultaneously from a single channel. With normal and event recordings, the video is divided evenly depending on the split-screen mode that has been selected. For example, if the video is an hour long and you have selected Split-screens x 4, each split-screen will play for 15 minutes.

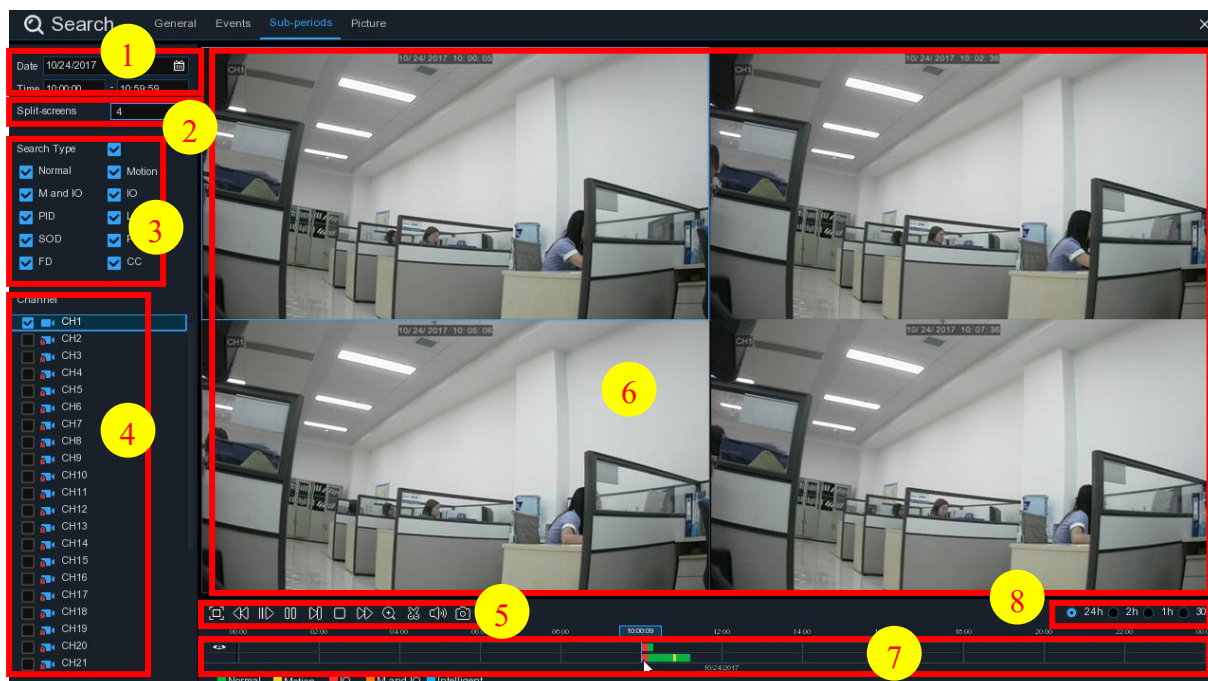

To search & play video in sub-periods:

- Choose the date & time you want to search.
- Choose the split-screens you want the videos to be played in.
- Check the recording types you want to search, or check **Search Type** to choose all.
- Choose the channels you want to search. Please note that this function only supports to search & play one channel at a time.
- Click the play button to start playing. Control the playback with buttons on **Video Playback Controls**.
- Videos are being played in split-screens.
- Click the left button of your mouse upon a particular split-screen, the time period of the video split-screen will be displayed on the timeline. The color bar on the top of the timeline indicates the time span of the video split-screen you have clicked. The color bar on the bottom of the timeline indicates the time span for the whole videos you have searched.



- Use the timeframe options (24h 2h 1h 30m) to view a smaller or larger time period.

6.1.4 Smart Search & Playback

Smart mode allows you to easily search & play the motion events in one or more specific areas of the channel.

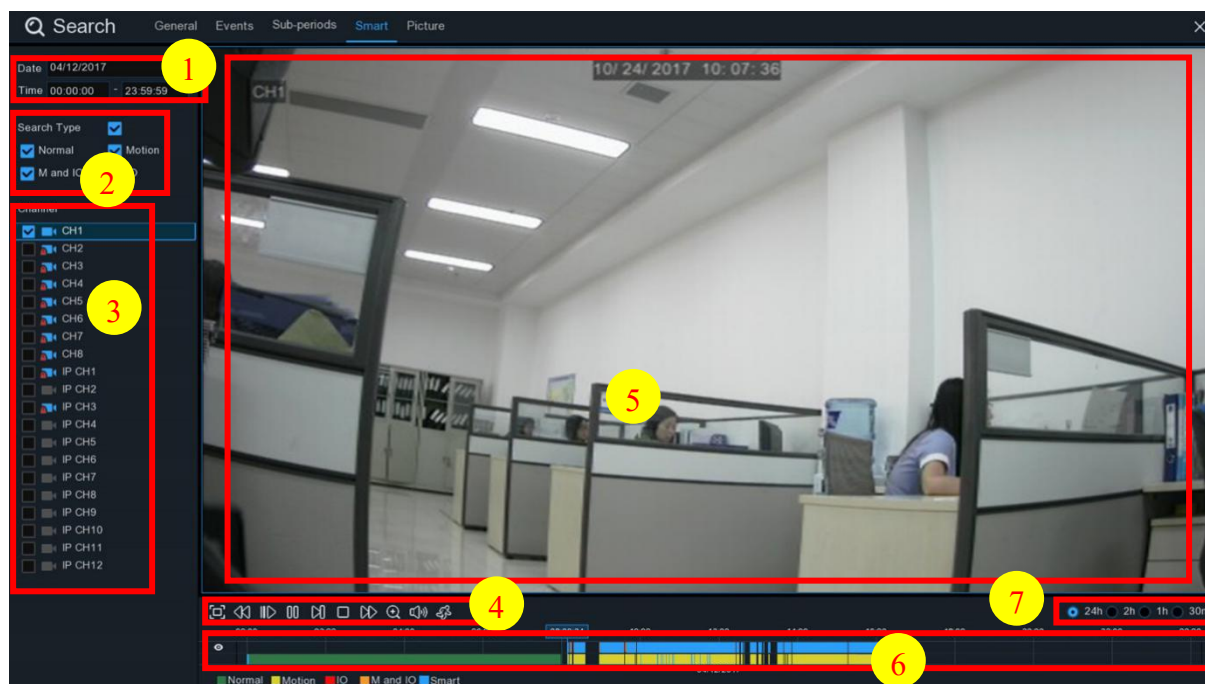

To start a smart search & playback:

1. Choose the date & time you want to search.
2. Check the recording types you want to search, or check **Search Type** to choose all.
3. Choose the channel you want to search, the motion recording in the selected channel will be searched automatically. Please note that this function only supports to search & play one channel at a time.
4. Click the play button  on the to start playing. Control the playback with buttons on **Video Playback Controls**.
5. Videos are being played in the screen.
6. The color bar on the top of the timeline indicates the time span of the motion recordings you have searched. The color bar on the bottom of the timeline indicates the complete time span for the whole recordings you have specified.

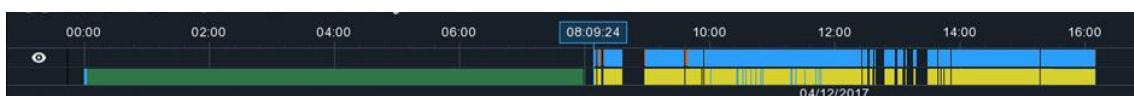

7. Use the timeframe options (   ) to view a smaller or larger time period.

6.1.4.1 Smart Search Area

The smart search function searches the motion recordings in the whole area of channel by default. You can specify one or more particular areas to narrow your search.





Click this icon  on **Video Playback Controls**, the camera will be shown in full screen and the Smart controls bar will be visible.



You can click and hold the edge of the controls bar to reposition it.

Smart Controls Bar



-  Click this to define a full screen detection area
-  Click this to delete all areas created.
-  Click this to search and play video based on the areas defined.
-  Click this to return to the playback interface.

To define one or more specific areas, please do the following:

1. Click and drag to select the area that you want to define. Multiple areas can be defined. You can also use the same action to remove sections of the defined area or to delete it entirely. When finished, click the search button to play video based on the areas defined.
2. You'll be returned back to the playback interface. Segments matching your search criteria will be shown on the timeline in blue color.

6.1.5 Picture Search & View

This function can be used to search, play and copy snapshots to a USB flash drive.

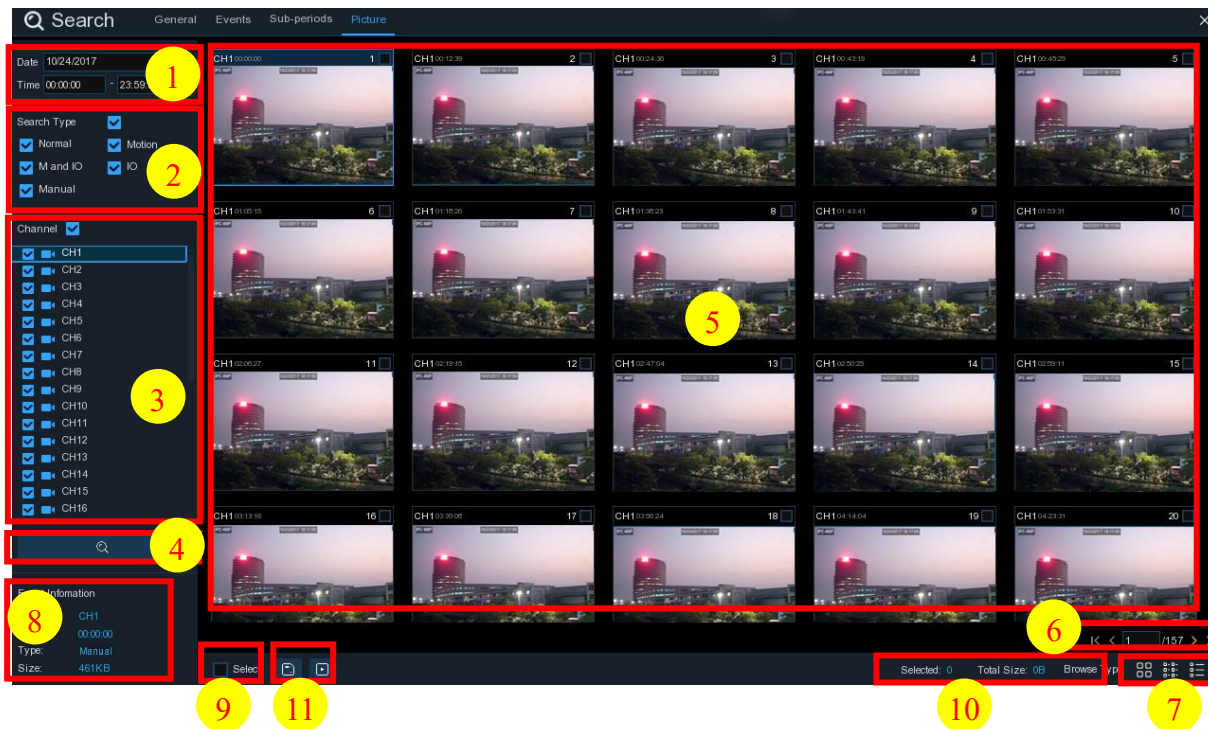

To search, play & back up pictures:

1. Choose the date & time you want to search.
2. Check the picture capture types you want to search, or check **Search Type** to choose all.
3. Choose the channels you want to search, or check **Channel** to choose all channels.
4. Click button to start search.
5. Pictures fitting your search criteria are displayed in list form. You can double click one of the pictures to get a larger view.
6. Click icons in the bottom-right corner of the menu to browse between pages of pictures, or input the page you want to browse.
7. You can switch the view of list form in by clicking below icons which is show at the right bottom corner of the screen:



Thumbnails view. You can view the snapshots of the events.





List view. The events will be displayed in list.

1	CH1	00:00:00	2	CH1	00:00:45	3	CH1	00:18:30	4	CH1	00:44:03	5	CH1	01:10:48	6	CH1	01:19:22	7	CH1	01:35:37
9	CH1	02:01:12	10	CH1	02:25:38	11	CH1	02:43:17	12	CH1	03:02:08	13	CH1	03:08:37	14	CH1	03:10:01	15	CH1	03:14:54
17	CH1	04:07:23	18	CH1	04:19:35	19	CH1	04:36:40	20	CH1	05:00:20	21	CH1	05:24:12	22	CH1	05:45:55	23	CH1	06:04:07
25	CH1	06:41:12	26	CH1	06:44:25	27	CH1	07:01:42	28	CH1	07:20:43	29	CH1	07:31:23	30	CH1	07:48:04	31	CH1	08:17:33
33	CH1	08:50:34	34	CH1	09:07:05	35	CH1	09:25:12	36	CH1	09:44:07	37	CH1	09:46:08	38	CH1	10:00:52	39	CH1	10:14:18
41	CH1	10:45:57	42	CH1	11:12:48	43	CH1	11:20:27	44	CH1	11:48:18	45	CH1	12:07:25	46	CH1	12:30:12	47	CH1	12:44:43
49	CH1	13:06:48	50	CH1	13:30:46	51	CH1	13:37:51	52	CH1	13:57:01	53	CH1	14:10:24	54	CH1	14:11:16	55	CH1	14:18:12
57	CH1	14:40:31	58	CH1	14:44:42	59	CH1	14:48:38	60	CH1	15:15:44	61	CH1	15:30:06	62	CH1	16:01:07	63	CH1	16:16:00











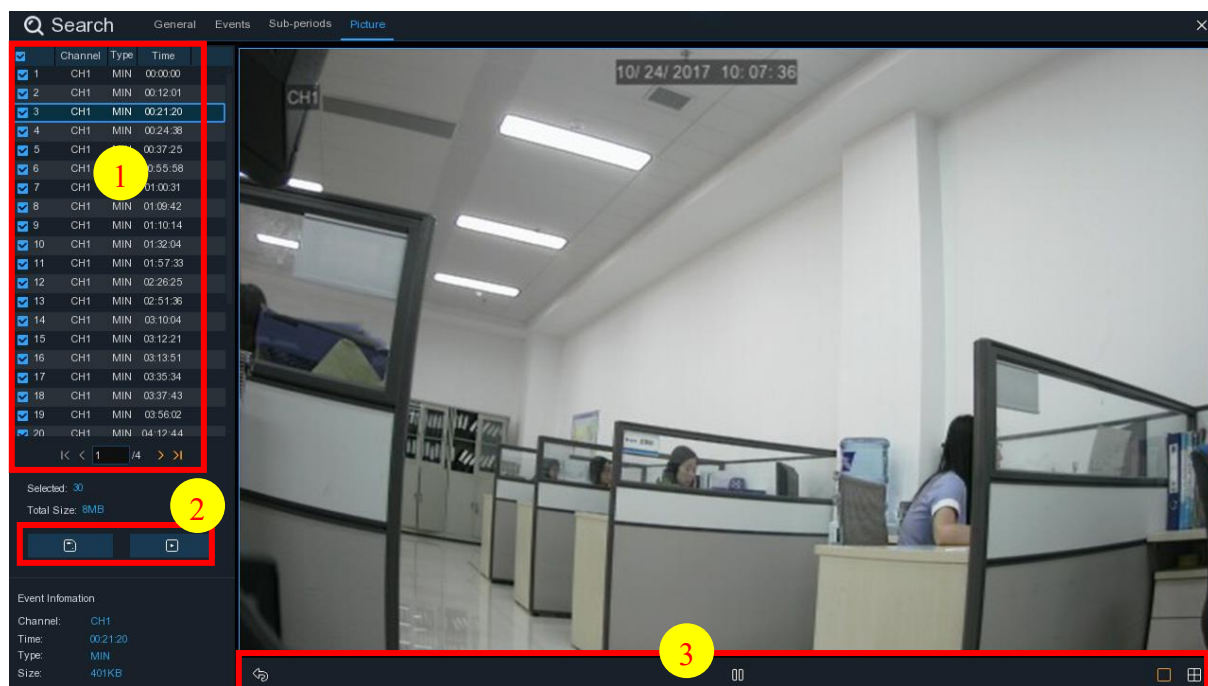

Detailed view. You can view the details of the events.

	Channel	Type	Date	Time	Size	Playback
<input type="checkbox"/> 1	CH1	MIN	10/24/2017	00:00:00	160KB	<input type="checkbox"/>
<input type="checkbox"/> 2	CH1	MIN	10/24/2017	00:12:01	201KB	<input type="checkbox"/>
<input type="checkbox"/> 3	CH1	MIN	10/24/2017	00:21:20	401KB	<input type="checkbox"/>
<input type="checkbox"/> 4	CH1	MIN	10/24/2017	00:24:38	111KB	<input type="checkbox"/>
<input type="checkbox"/> 5	CH1	MIN	10/24/2017	00:37:25	167KB	<input type="checkbox"/>
<input type="checkbox"/> 6	CH1	MIN	10/24/2017	00:55:58	210KB	<input type="checkbox"/>

- When you click the left button of your mouse upon one of the pictures, system will show the picture information on the left bottom corner of the screen.
- Check the box next the number of the event to select files, or check the box next **Select** to select all pictures in the page.
- The number of selected files, total size information will be displayed at the right bottom of the screen.
- After selecting file, you can click  button to save the pictures to USB flash drive. Or click  button to go into picture preview control window.

6.1.5.1 Picture Preview Control



- Picture List, you can select the pictures here.
- Click  button to save your selected pictures to a USB flash drive. Click  button to view the pictures in slideshow.
- Press  button to exit preview control window and go back to picture search window.
 Press  button to pause, press  to resume slideshow.
 Press  button to display previous snapshot or group of snapshots, press  to display the next snapshot or group of snapshots.
 Click  button to view a single snapshot at a time, click  button to view four snapshots at a time, press  buttons to view nine snapshots at a time.

Chapter 7 Remote Access via Web Client

Use the Web Client to remotely access your DVR at any time via a PC. Before you access the Web Client, you need to ensure that the internet settings of the DVR are configured properly.

7.1 Basic System Environment Requirements

The minimum requirements for hardware and OS required to run Web Client are given as below.

Item	Minimum	Recommended
CPU	Intel® Core™ i5 CPU	Intel® Core™ i5 CPU or higher
RAM	4G or more	8G or more
Hard Drive	500G or more	1000G or more
Display RAM	2G or more	4G or more
Display Resolution	1280*1024	1920*1080
OS	Windows 7 or above Mac OS X® 10.9 or above	
DirectX	DirectX 11	
Direct3D	Acceleration Function	
Ethernet Adapter	10/100/1000M Ethernet Adapter	
IE	Microsoft Internet Explorer (Ver. 11,10,9,8). It doesn't support Edge.	
Mozilla Firefox	V51 or below. It doesn't support V52 or above version.	
Google Chrome	V44 or below. It doesn't support V45 or above version.	
Mac Safari	5.1 or above	

7.2 Web Plugin Download and Installation

To access the Web Client, do the following:

For IE/Chrome/Firefox:

1. Launch the explorer on your PC and enter the DVR IP address or DDNS domain name (Host Name) you have set on DVR in the URL box.
2. For the first time you run the web client, system will require to install the web client plugin. Click **download** to download the plugin and install to your computer.

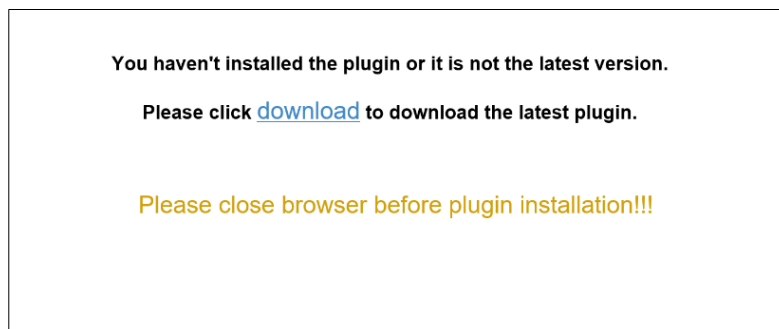

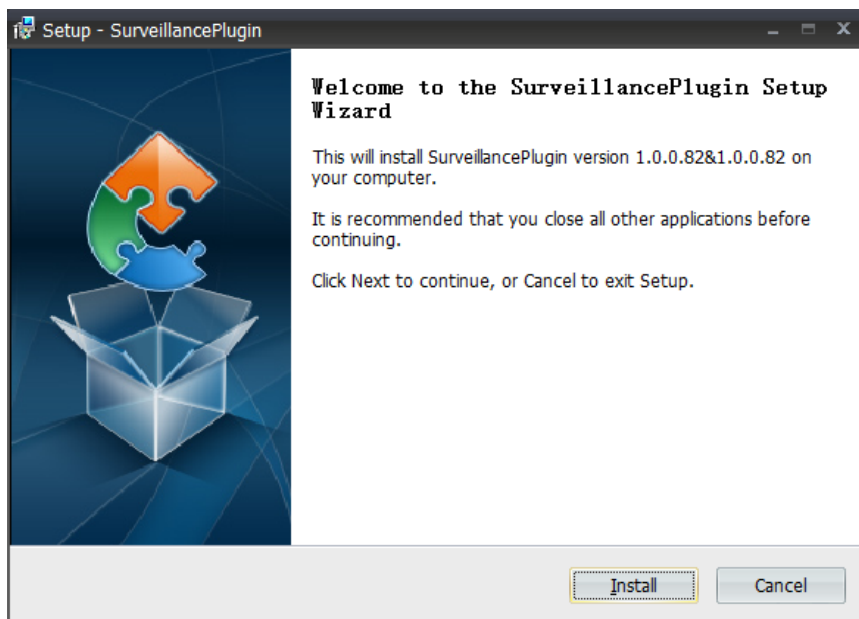

3. After installing the plug-in, close & launch again your browser and repeat step 1 to open the login page. Input your user name and password to login the web client.

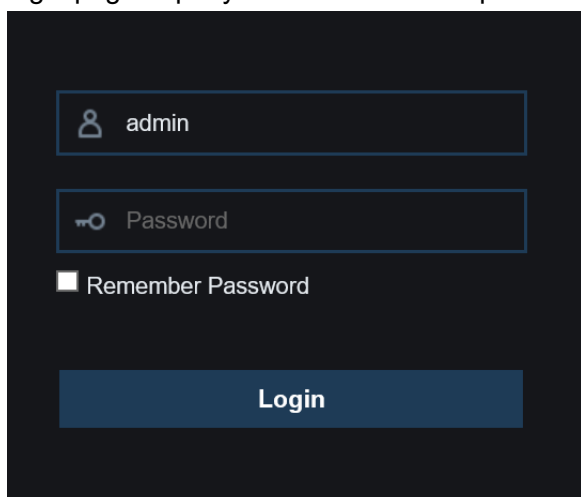

Note: If you use Google Chrome, please use Version V41 or below. If you use V42 to V44, you need to enable NPAPI plugins. Please enter <chrome://flags/#enable-npapi> on URL bar to find and enable NPAPI. It doesn't support V45 or above so far.

For Mac Safari:

1. Launch the Safari in your Mac, and enter the DVR IP address or DDNS domain name (Host Name) you have set on DVR in the URL box.

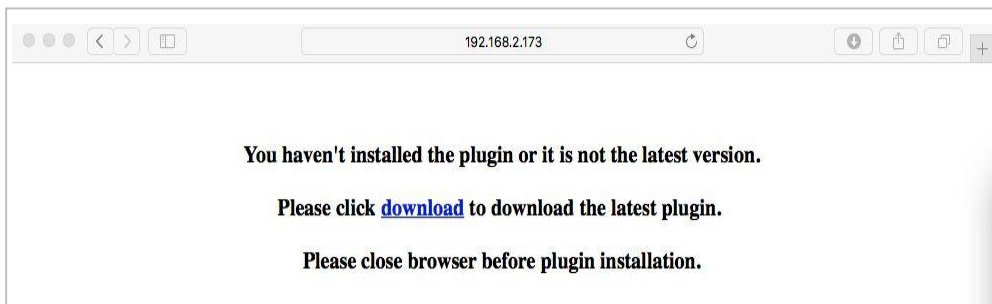

2. Download the plug-in "SurveillanceClient.dmg", locate the downloaded file and double click it.

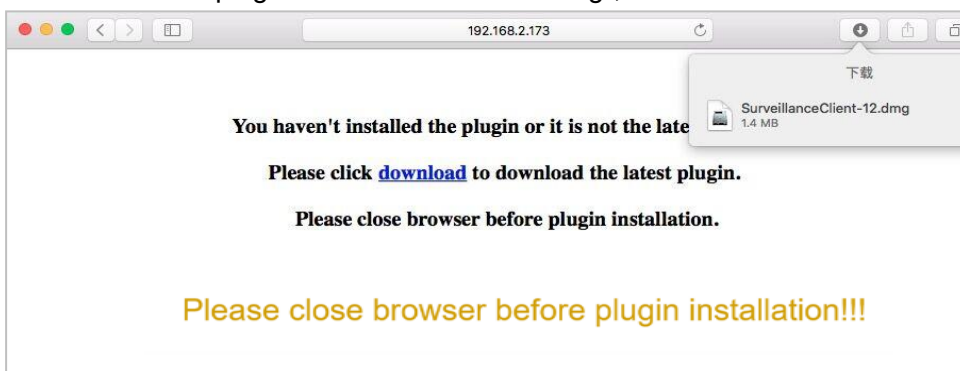

3. Click on "Continue" --> "Install". Enter user name and password for Mac computer, Click on "Install Software" --> "Close" to finish installation.

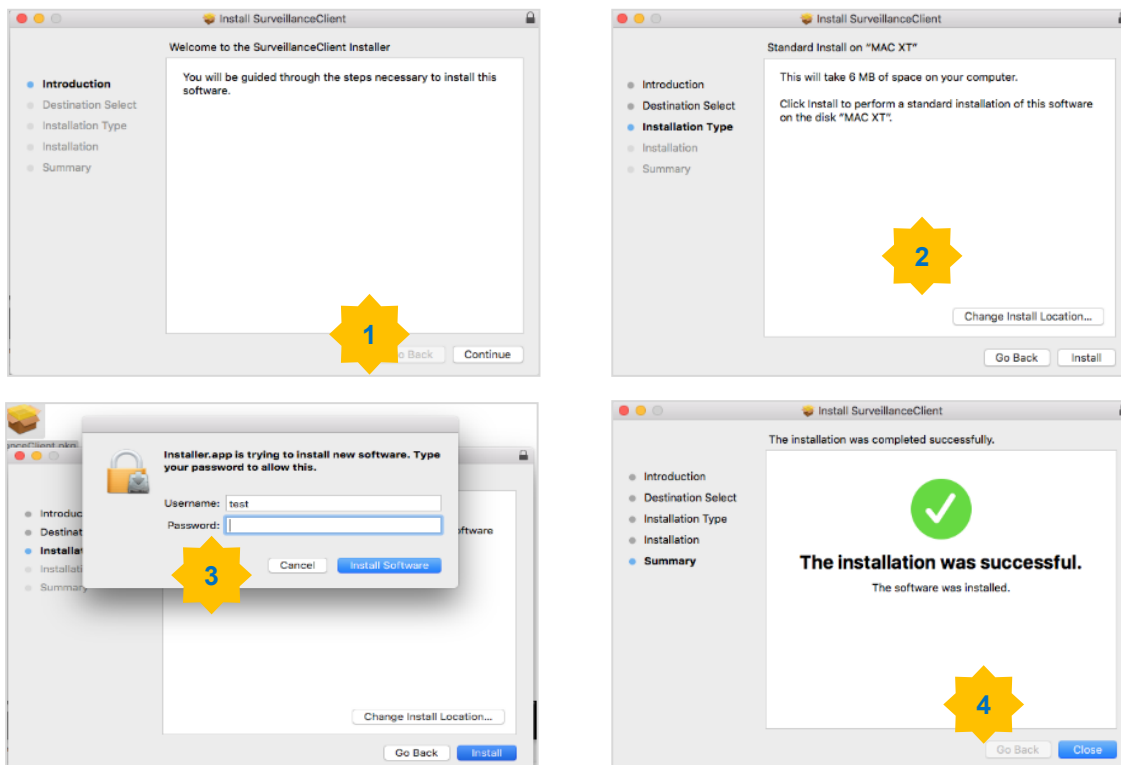

4. Close Safari and open again to repeat step 1 to open the Web Client login page.

7.3 Web Client Manager

The web client supports to fully control the DVR with administrator account. Please make sure to protect your user name & password for preventing illegal login.

7.3.1 Live Interface

This is the first screen that opens after you have logged in to the Web Client. Here you can open or close live preview, record video to local computer manually, take snapshots of the screens, PTZ control, color adjustment, etc.

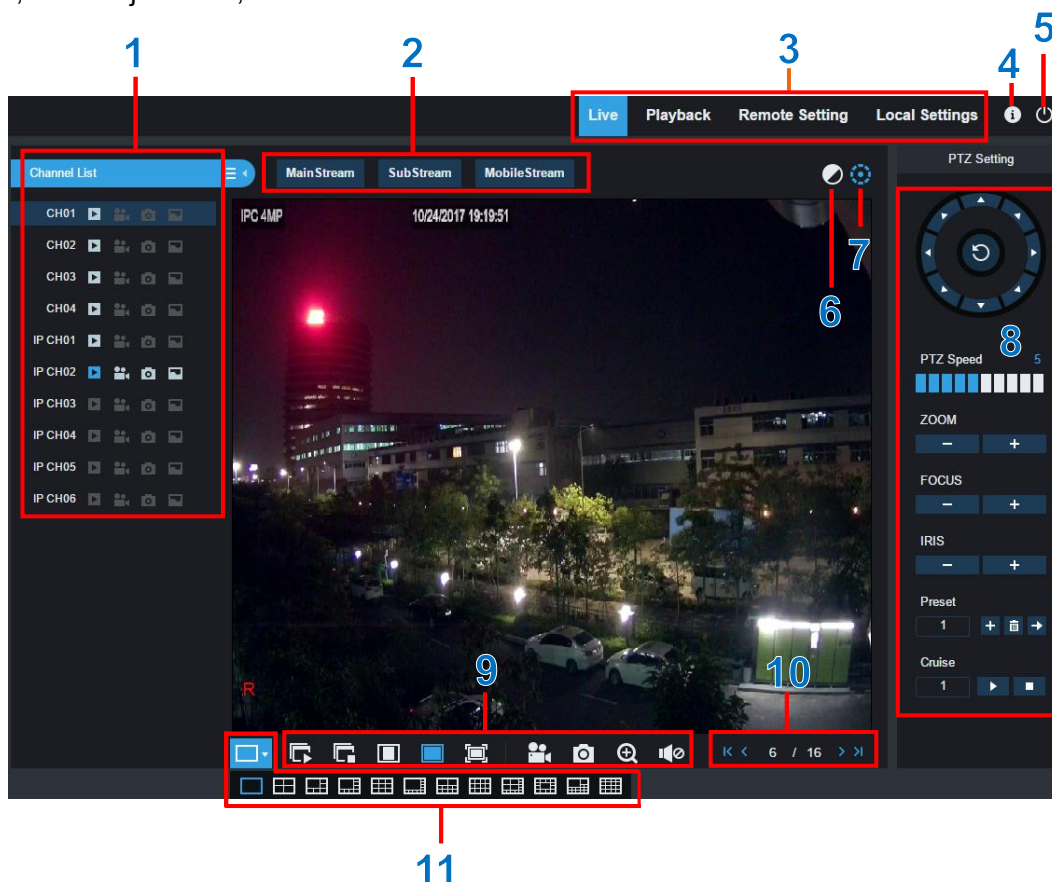

1- Channel List: Open the channel list for quick camera function

- Click button to display the Channel List.
- Click button to hide the Channel List.

- Turn the Live video stream on/off. The button is in blue color if the live video stream is on.
- Manual Recording buttons. Click to start manually recording live stream video. Click again to stop recording. Manual recordings are saved to your computer. While in recording, the button is in blue color.
- Manual snapshot button. Click to save a snapshot of the current live display to your computer.
- Bitrate button. Set camera to use mainstream, substream or mobile stream video settings. Mobile stream is available for IP channels only.

2- **Live Video Stream Options:**

Mainstream: View all live videos using high-quality mainstream video settings.

Substream: View all live videos using middle-quality substream video settings.

Mobile Stream: View all live video using lower-quality mobile stream video settings to conserve bandwidth. Available for IP channels only.

3- **Main Menus:**

Live: View live video from cameras.

Playback: View recorded video which is saved in DVR's HDD.

Remote Setting: Access functions of the DVR setting menus.

Local Settings: Set download locations for recordings and snapshots taken using Web Client, and choose file type for video files.

4- **Information:** Hover over to see system details.

5- **Exit.**

6- **Color Controls.** Click to display or hide the color controls.



7- **PTZ Controls:** Click to display or hide the PTZ controls for using PTZ cameras.

8- **PTZ Controls**

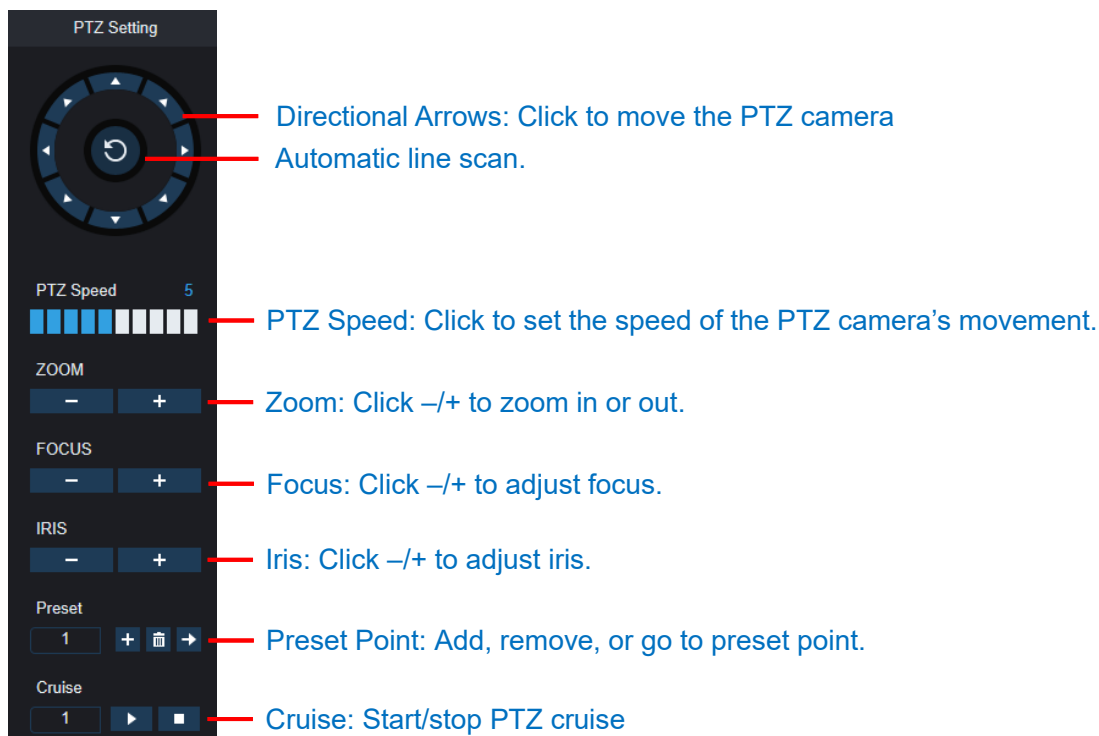

9- Live View Control Buttons:



- Open the images on Live window.
- Close all the Live channels
- Original Proportions: Shows live video at the original proportions
- Stretch: Stretch live video to fit the full area for each channel on screen.
- To enlarge the web client to full screen.
- Manual Recording: Click to start manually recording for all displayed channels. Click again to stop recording. Manual recordings are saved to your computer.
- Snapshot: Click to save snapshots of all current displayed channels to your computer.
- Digital Zoom: Click upon on a live image, then click-and-drag over an area of the live image to enlarge. Right-click to return to the normal display.
- Volume Control. Volume is mute.

10- Navigation: Shows current page number for the channels shown on screen. Use the arrow keys to switch between pages.

11- Page View: Click to select how many channels appear on screen at a time.

7.3.2 Playback

You can search & play recording videos stored in the HDD inside the DVR, and download the videos to your computer.

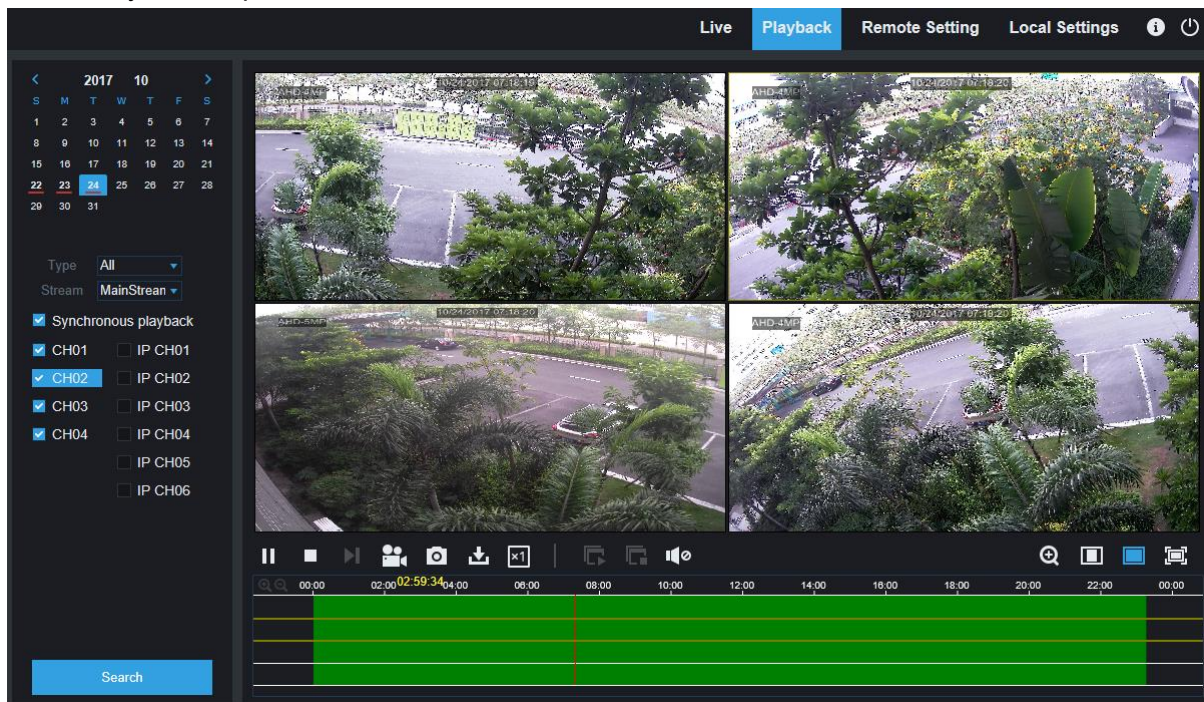

To search recordings:

1. Click **Playback** in the top-right corner of the window.
2. Select a day on the calendar to search for recordings from. Days with recordings appear with a red underline.
3. Select the recording type to search for from the dropdown next to **Type**, or select **All** to search for all recordings.
4. To choose the video stream you want to search & play. If you want to play Substream recordings, please make sure you had set the DVR to record with Dualstream at [5.2.2.1 Record](#).
5. Check the channels you would like to search for recordings from. Check **Synchronous playback** to play all channels at once.
6. Click **Search**.
7. Recordings that fit your search will be displayed in the timeline. Click a section of video where you would like to begin playback and click the ► play button.

7.3.2.1 Playback Control Buttons

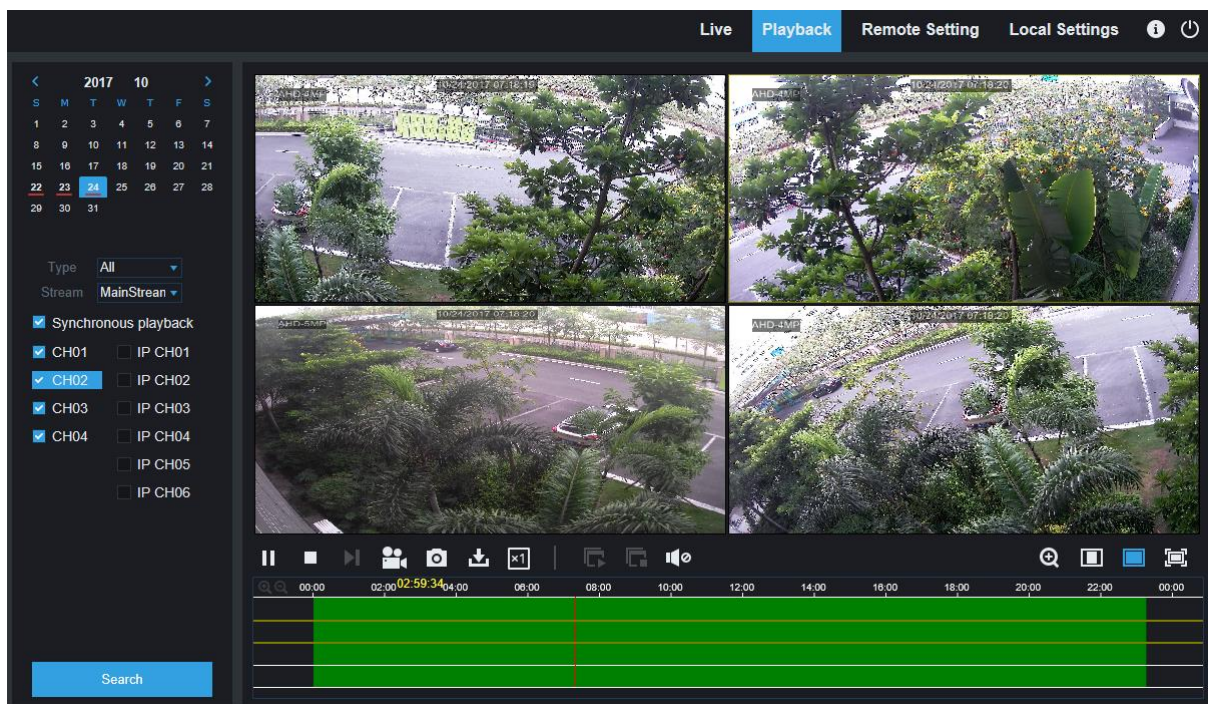



► Play the recordings

|| Pause

■ Stop

► Go Forward One Frame: Move frame-by-frame through playback. Only available when the **Synchronous playback** option is not checked.

 Click upon one of the channels which is being played and then click record button to record current video to your computer. Click again to stop recording.

 Click upon one of the channels which is being played and then click capture button to take a snapshot and save to your computer.

 Opens the Download menu, which allows you to download several video recordings at once.

	<input type="checkbox"/>	Start Time	End Time	Status	File Size
1	<input checked="" type="checkbox"/>	2017-10-25 00:00:00	2017-10-25 00:01:04	Completed	47.00M
2	<input checked="" type="checkbox"/>	2017-10-25 00:01:04	2017-10-25 00:06:56	2%	253.76M
3	<input type="checkbox"/>	2017-10-25 00:06:56	2017-10-25 00:12:48	Not Downloaded	253.71M
4	<input type="checkbox"/>	2017-10-25 00:12:48	2017-10-25 00:18:41	Not Downloaded	253.91M
5	<input type="checkbox"/>	2017-10-25 00:18:41	2017-10-25 00:24:34	Not Downloaded	253.64M
6	<input type="checkbox"/>	2017-10-25 00:24:34	2017-10-25 00:30:27	Not Downloaded	253.68M
7	<input type="checkbox"/>	2017-10-25 00:30:27	2017-10-25 00:36:18	Not Downloaded	253.75M
8	<input type="checkbox"/>	2017-10-25 00:36:18	2017-10-25 00:42:10	Not Downloaded	253.90M
9	<input type="checkbox"/>	2017-10-25 00:42:10	2017-10-25 00:48:03	Not Downloaded	253.74M
10	<input type="checkbox"/>	2017-10-25 00:48:03	2017-10-25 00:53:56	Not Downloaded	253.63M

10 | 1 / 10 | Show from 1 to 10, total 95. Per page : 10

Start Download Stop Download

Choose the files you want to download, press **Start Download** button to begin, you will see the download status. Press **Stop Download** button to stop.

 **Playback Speed.** Click to choose the playing speed.

 **Play All Channels:** Click to play all channels you have chosen to searched. Only available when the **Synchronous playback** option is not checked.

 **Stop All Channels:** Click to stop playing all channels. Only available when the **Synchronous playback** option is not checked.

 **Digital Zoom:** Click upon on a playing video, then click-and-drag over an area of the video to enlarge. Right-click to return to the normal display.

 **Original Proportions:** Shows the playing video at the original proportions

 **Stretch:** Stretch the playing video to fit the full area for each channel on screen.

 To enlarge the web client to full screen.

7.3.3 Remote Setting

Here you can remotely configure the settings of the DVR. Please see “[Chapter 5 DVR System Setup](#)” for more details on the DVR settings..

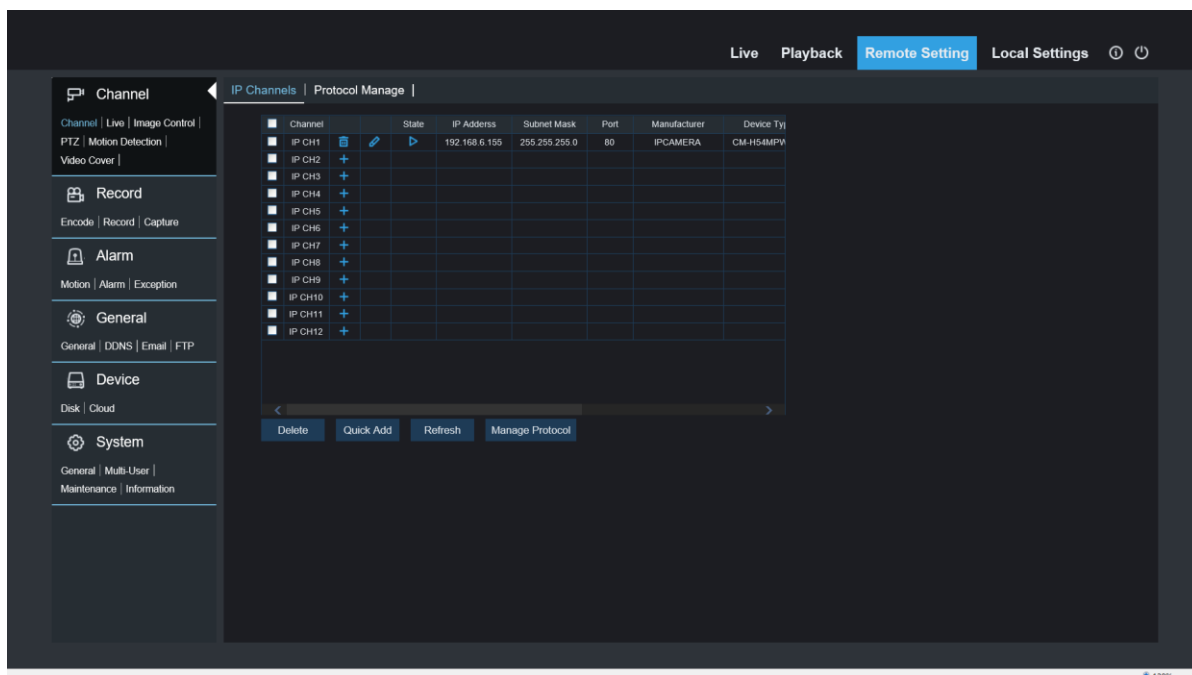

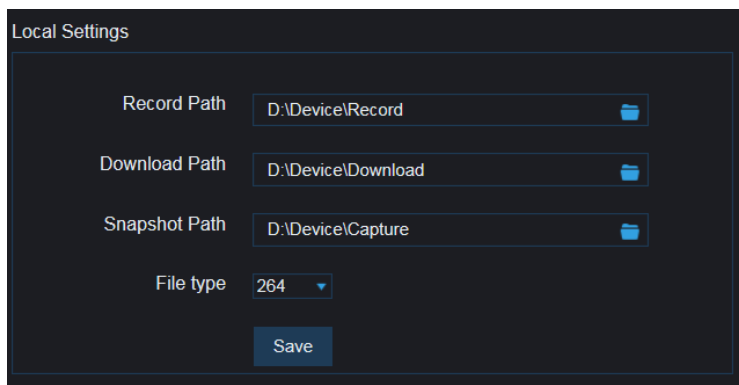

7.3.4 Local Setting

Set download locations for recordings and snapshots taken using Web Client, and choose file type for video files.



Record Path: Click  to browse for and select the folder where you would like the manual video recordings to be saved on your computer.

Download Path: Click  to browse for and select the folder where you would like to save the download video recordings to your computer.

Snapshot Path: Click  to browse for and select the folder where you would like the manual capture snapshots to be saved on your computer.

File Type: Choose your preferred file type for manual recordings.

Save: Click to save the modifications.

Chapter 8 Viewing Backed Up Video on PC/Mac

This section will help you to play the backup files with the powerful video player which is attached in the CD.

For Mac users, please install the app “VideoPlayer_x.x.xx_xxxx_xx_x.dmg”, for example:

VideoPlayer_1.0.15_2017_01_6.dmg.

For PC users, please install the software “VideoPlayer_x.x.xx_xxxx_xx_xx.exe”, for example:

VideoPlayer_1.0.15_2017_01_06.exe.

Minimum System Requirements

- Intel Pentium 4 or above
- Microsoft Windows XP / Vista / 7 / 8 / 10
- 256MB RAM
- 16MB video memory

1. Install the Video Player software in the CD and run.

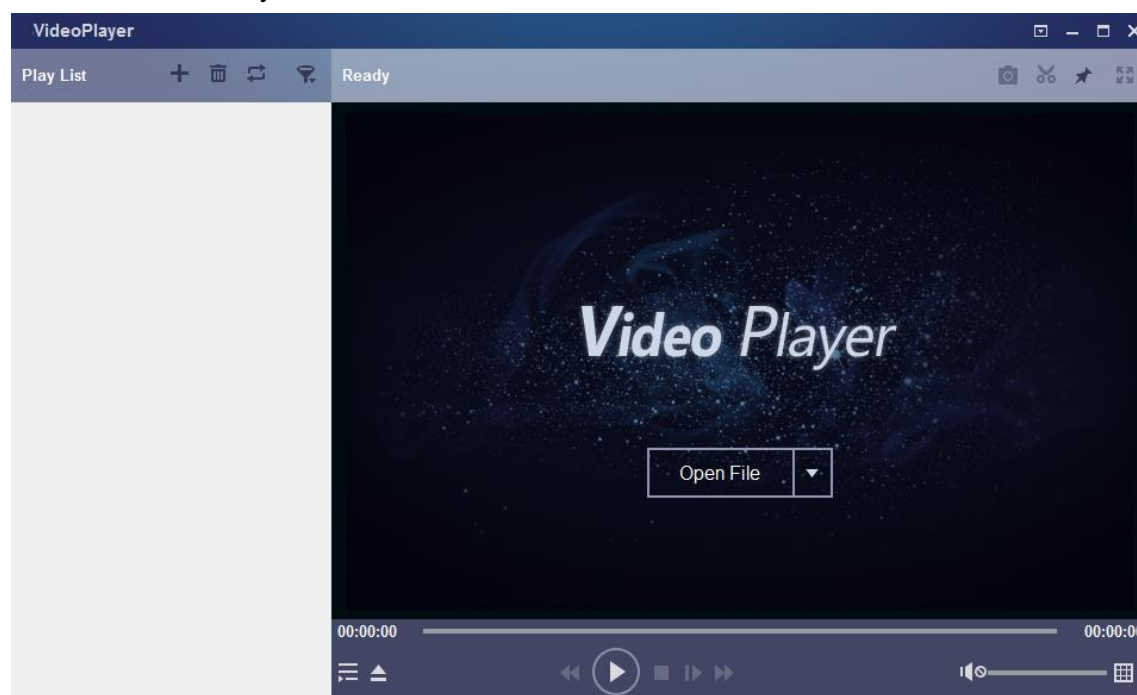





2. Copy the backup files to your computer.
3. Click **Open File** button or click **+** button on the Play List to load single or multiple video files. It supports to add & play “.rfl”, “.avi”, “.mp4”, “.264” and “.265” files. Click **▼** button to load a folder with backed-up videos.

Video Player Control









1. Play List

-  Add files
-  Remove files
-  To choose play mode: play a single file and stop; play all listed files by sequence; repeat one file; repeat all files.
-  Filter by file name

2. Hide/Show Playlist

-  Click to open files or load a folder.



3. Play Controls

-  Play
-  Pause
-  Stop
-  Play frame by frame. Click once to play a frame of the video
-  Slow Play, 1/2, 1/4 and 1/8, 1/16 speed
-  Fast Forward, x2, x4, x8 and x16

4. Volume control

-  Multi-screen play. It allows to play multiple videos at a time. When you choose multi-screen, you can drag the video in Play List to the play screen.

5. Take snapshot

-  To save a video clip to your computer. Press once to start, press again to end the video clip.
-  Keep the video player on top

 Enlarge the video play screen to full screen

6.  **Advanced Setup Menu** allows to choose the OSD language of the video player, and configure the setting of video player.

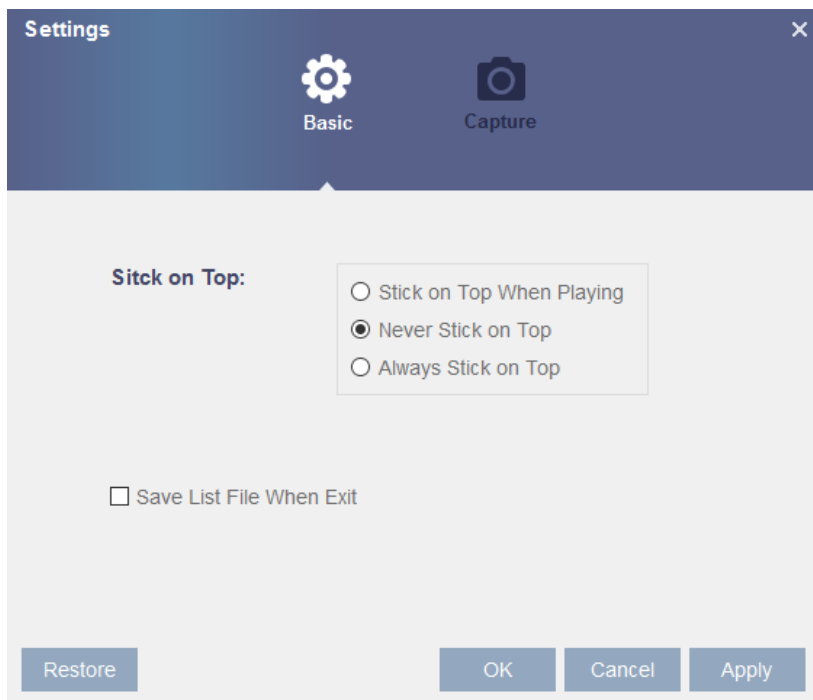

Basic Settings: Set on-top mode

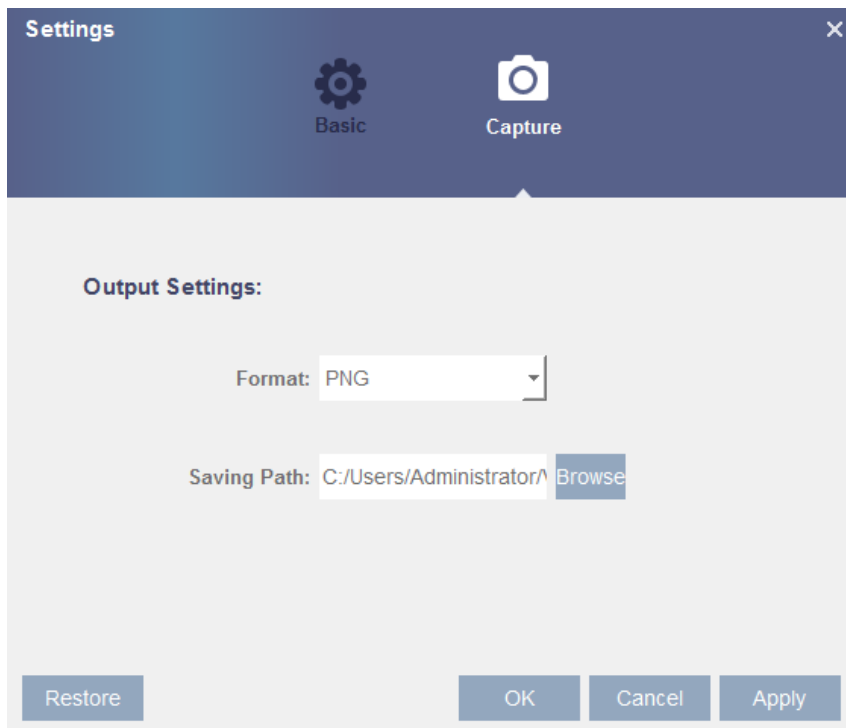



Capture Settings: Set the format and the path to save snapshots.

Chapter 9 Remote Access via Mobile Devices

The DVR supports to remote access via mobile devices based on Android & iOS operating system.

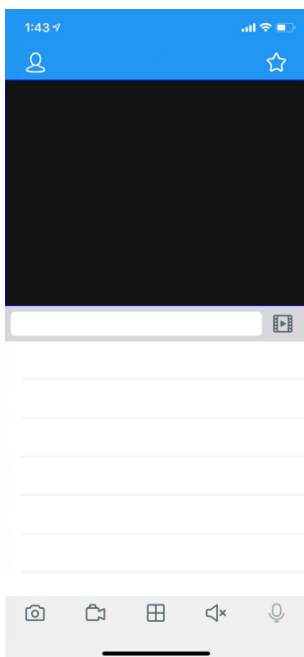
- 1) Search KViewPro from Google Play Store for android devices or App Store or iOS devices and install.
- 2) Run the app, it will display the live view screen.



- 3) Touch the  icon and “Device List” to open device list page, touch + to add device.

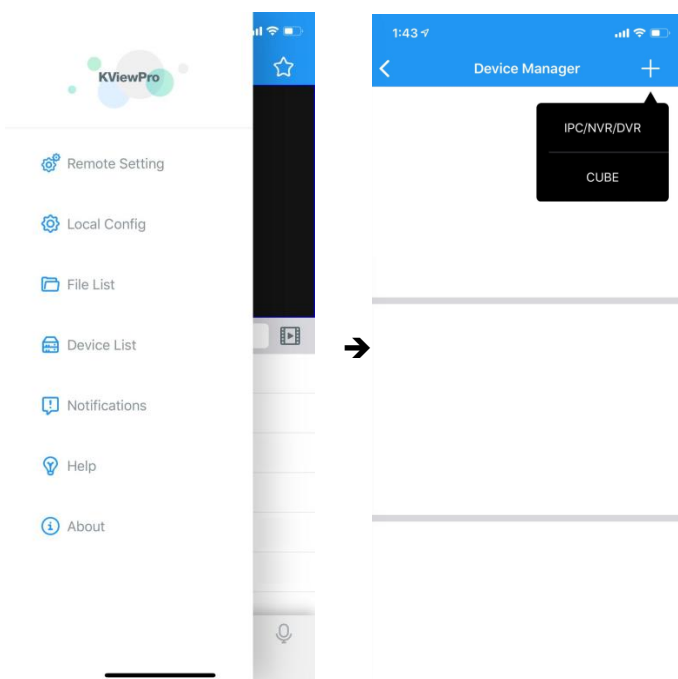

- 4) Choose “IPC/NVR/DVR”, and Scan the P2P QR Code or “Manual Add” and input the DVR information(IP Address/ID , Media Port , User Name , Password).

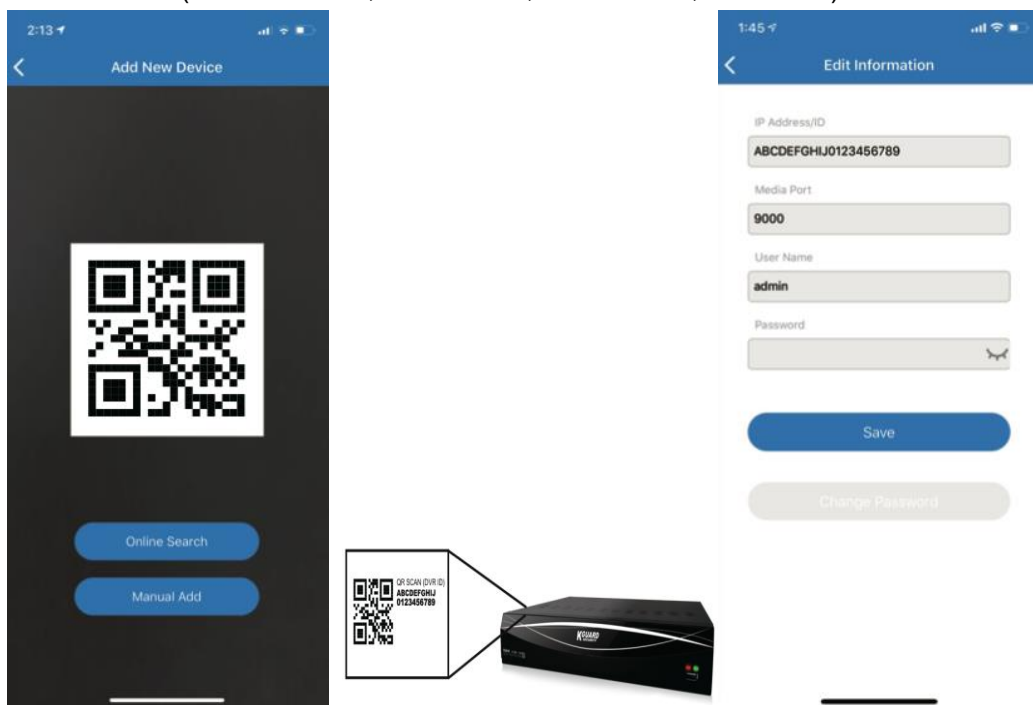

- 5) After all settings completed, touch **Save** to save, the app will turn to Live view display if the device is well connected.

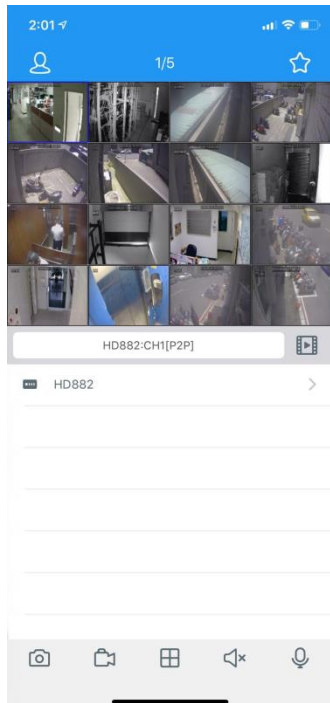

Chapter 10 Appendix

10.1 Troubleshooting

1. **Q:** What can I do if the system does not detect the HDD?
A: Check if the power supply system is properly connected and data cord and power cables are securely connected, and if something wrong with the HDD interface. Or you may check if your HDD is supported by referring to the specifications or descriptions.
2. **Q:** I have changed the password but forget the new password, how can I access the system?
A: If you forget system password, please consult with our technical personnel by email support@kguardsecurity.com. We strongly suggest user to set password easy to be remembered and relatively safe. If you have safety requirement, please do not set very simply password, such as 000000.
3. **Q:** We see abnormal video signal or even no video signal by connecting the DVR and camera together. Power supply for both devices is OK. What is wrong?
A: Check network cable at DVR side to see if the cable is firmly connected and if it is worn out and needs to be replaced, or to check if NTSC or PAL is selected consistently.
4. **Q:** How to prevent DVR from being influenced by heat?
A: The DVR needs to dissipate heat while it is running. Please place the DVR in a place with good air circulation and away from heat sources to ensure stability and life of the DVR.
5. **Q:** The remote controller of DVR doesn't work while the monitor screen is OK and panel keys are functional. Why?
A: Operate again by aiming the remote controller at the IR receiver on front panel. If it still doesn't work, please check if the batteries in the remote controller are dying. If not, check if the remote controller is broken.
6. **Q:** I want to take out HDD from my PC and install it in DVR. Can it work?
A: All HDDs supported by the system can be used. But remember, once DVR runs, the data on your HDD will be lost.
7. **Q:** Can I playback while recording?
A: Yes. The system supports the function of playing while recording.
8. **Q:** Can I clear some records on HDD of DVR?
A: In consideration of the file security, you may not clear part of records. If you want to remove all the records, you can format HDD.
9. **Q:** Why can't I log in DVR client?
A: Please check if the network connection settings are correct and RJ-45 port is with good contact. And check if your account and password are correctly input.
10. **Q:** Why can't I find any records during playback?
A: Please check if the data line connection for HDD is OK and system time is properly adjusted. Try a few times and restart. If it still doesn't work, check if the HDD is broken.
11. **Q:** Why DVR cannot control PTZ?
A: Please check if:
 - a) PTZ in the front side is malfunctioned.
 - b) Setting, connection and installation of PTZ decoder are not correct.

- c) PTZ setting of DVR is not correct.
 - d) Protocol of PTZ decoder does not match that of DVR.
 - e) Address of PTZ decoder does not match that of DVR.
 - f) If many decoders are connected, the farthest side of AB line of PTZ decoder should be added 120Ω resistance to realize reflection suppression and impedance matching. Otherwise, PTZ control will be unstable.
12. **Q:** Why doesn't dynamic detection work?
A: Please check if the motion detection time and motion detection regional setting are correct and if the sensitivity is set too low.
13. **Q:** Why doesn't alarm work?
A: Please check if the alarm setting, alarm connection and alarm input signals are correct.
14. **Q:** Why does buzzer keep alarming?
A: Please check the alarm setting, check if motion detection function is enabled and object motion is detected all the time and if I/O alarm is set as Always Off. Besides, refer to corresponding HDD alarm setting.
15. **Q:** Why can't I stop recording by pressing "STOP" button or click "Stop Recording" in context menu?
A: Pressing Stop or Stop Recording can only stop manual record. If you want to stop Scheduled recording in certain time quantum, please change the setting to No Record. To stop Startup recording, please change record mode to scheduled recording or manual recording. Then you may stop recording by the prescribed methods. And another way of stopping recording is to set channel as off status in record setting.

10.2 Usage Maintenance

1. To shut down DVR, please firstly shut down the system and then turn off the power. Do not turn off the power directly or HDD data will be lost or damaged.
2. Please keep DVR away from heat sources or places.
3. Clean the internal dust regularly. Make sure the good ventilation of DVR so as to ensure the good heat dissipation.
4. Please do not hot plugging audio and video cables, or cables connected to ports like RS-232 or RS-485. Otherwise the ports will be damaged.
5. Please check the HDD cable and data cable regularly to see if they are ageing.
6. Please prevent the audio and video signals of DVR from being intervened by other electronic devices, and prevent the HDD from being damaged by static electricity and induced voltage. If the network cable is frequently plugged, it is suggested to replace connecting line regularly, or the input signal may be unstable.
7. This is a class A product. It maybe bring wireless interference in life. Under this situation, it need user to make measures



Copyright © 2020
All rights reserved

Customer Support

KGUARD INFORMATION CO., LTD.

Address: 4F, No.113, Jian 2nd Road,
Jhonghe District, New Taipei City 23585, Taiwan

TEL: +886-2-8228-6080

FAX: +886-2-8221-6857

Email: support@kguardsecurity.com

Facebook: <https://www.facebook.com/kguardtw/>
